

HIOKI

Instruction Manual
使用说明书

DT4211

DT4212

DIGITAL MULTIMETER
数字万用表

HIOKI E. E. CORPORATION
日置電機株式会社

November 2013 Revised edition 1
2013年11月 修订一版

DT4211A981-01 13-11H

Contents

Introduction.....	1
Verifying Package Contents	1
Options (sold separately)	2
Safety Notes.....	4
Usage Notes.....	8

1 Overview **15**

1.1 Overview and Features.....	15
1.2 Parts Names and Functions.....	16
1.3 Display	21

2 Preparation for Measurements **23**

2.1 Measurement Workflow	23
2.2 Inserting/Replacing Batteries	24
2.3 Using Test Leads.....	26

3 Performing Measurements **29**

3.1 Inspection Before Use	29
3.2 Measuring Voltage.....	33
Measuring AC voltage.....	33
Measuring DC voltage	34
3.3 Measuring Resistance	35
3.4 Measuring Diode	36
3.5 Checking Continuity	37
3.6 Measuring Electrostatic Capacities.....	38
3.7 Measuring Frequencies	39
3.8 Measuring Duty Ratio	40
3.9 Measuring Current	41
Measuring DC/AC.....	41

3.10	Measuring Temperatures (DT4212).....	43
4	Using Instrument Conveniently	45
4.1	Selecting the Measurement Range.....	45
	Measuring with the auto range	45
	Measuring with the manual range.....	45
4.2	Retaining the Measured Value	46
	Retaining the measured value (HOLD).....	46
4.3	Checking the Relative Value/Performing Zero Adjustment.....	47
	Checking the relative value (REL)	47
	Performing zero adjustment.....	48
4.4	Turning On the Backlight.....	49
4.5	Using the Auto Power Save (APS).....	49
5	Specifications	51
5.1	General Specifications	51
5.2	Electrical Characteristics	53
5.3	Accuracy Table	55
6	Maintenance and Service	63
6.1	Repair, Inspection, and Cleaning.....	63
6.2	Troubleshooting	64
6.3	Replacing Fuses.....	67
Appendix		Appx.1
	Appx. 1 RMS and Average	Appx.1

Introduction

Thank you for purchasing the HIOKI DT4211 (Average value measurement model), DT4212 (True RMS measurement model) Digital Multimeter.

To obtain maximum performance from the product, please read this manual first, and keep it handy for future reference.

Verifying Package Contents

When you receive the instrument, inspect it carefully to ensure that no damage occurred during shipping.

In particular, check the accessories, panel switches, and connectors. If damage is evident, or if it fails to operate according to the specifications, contact your authorized Hioki distributor or reseller.

Check the package contents as follows.

- DT4211 (Average value measurement model) or DT4212 (True RMS measurement model)**

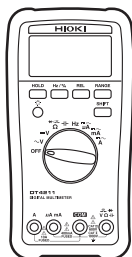

DT4211

(Average value
measurement model)

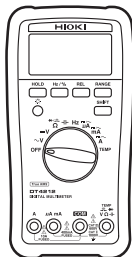

DT4212

(True RMS
measurement model)

- L9206 Test Lead
(p. 27)**

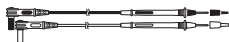

- R6P manganese battery × 2**



- Instruction Manual**



The holster has been attached.

Options (sold separately)

The following options are available for the instrument. Contact your authorized Hioki distributor or reseller when ordering.

Connecting cables

*1: CAT IV 600 V/CAT III 1000 V/CAT II 1000 V

*2: CAT IV 600 V/CAT III 1000 V

*3: CAT III 1000 V *5: CAT III 300 V/CAT II 600 V

*4: CAT III 600 V *6: AC33 V /DC70 V

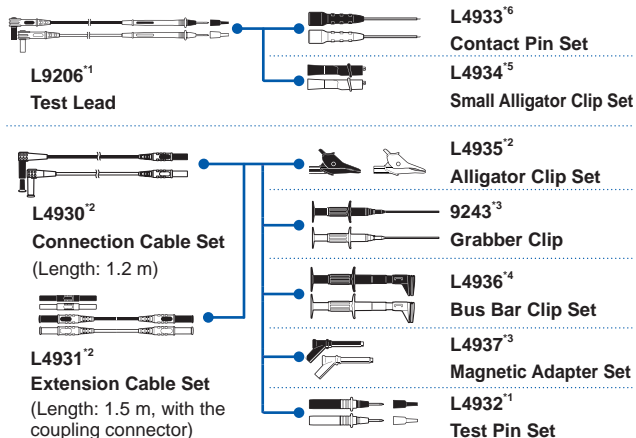

Temperature measurement (Only the DT4212 (True RMS measurement model))

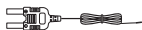

DT4910 Thermocouples (K) (p. 43)

- Temperature measuring junction: Exposed type (welding)
- Sensor length: Approx. 800 mm
- Operating temperature: -40°C to 260°C (temperature measuring part), -15°C to 55°C (connector)
- Allowable tolerance: $\pm 2.5^{\circ}\text{C}$

Carrying Case



C0201 Carrying Case

The instrument, test leads, instruction manual, and others can be stored in the case.



C0202 Carrying Case

The instrument, test leads, instruction manual, and others can be stored in the case.

Z5004 Magnetic Strap



Attach this strap to the instrument and secure it on the wall surface such as a metal plate for use.
Handling the strap (p. 11)

For the detailed procedure of the C0201 Carrying Case and Z5004 Magnetic Strap, refer to our Website.

Safety Notes

This instrument is designed to conform to IEC 61010 Safety Standards, and has been thoroughly tested for safety prior to shipment. However, using the instrument in a way not described in this manual may negate the provided safety features.

Before using the instrument, be certain to carefully read the following safety notes.

DANGER



Mishandling during use could result in injury or death, as well as damage to the instrument. Be certain that you understand the instructions and precautions in the manual before use.

WARNING



With regard to the electricity supply, there are risks of electric shock, heat generation, fire, and arc discharge due to short circuits. If persons unfamiliar with electricity measuring instruments are to use the instrument, another person familiar with such instruments must supervise operations.

Protective gear







WARNING











To avoid electric shock when measuring live lines, wear appropriate protective gear, such as insulated rubber gloves, boots and a safety helmet.

Notation



In this manual, the risk seriousness and the hazard levels are classified as follows.

 DANGER	Indicates an imminently hazardous situation that will result in death or serious injury to the operator.
 WARNING	Indicates a potentially hazardous situation that may result in death or serious injury to the operator.
 CAUTION	Indicates a potentially hazardous situation that may result in minor or moderate injury to the operator or damage to the instrument or malfunction.
IMPORTANT	Indicates information related to the operation of the instrument or maintenance tasks with which the operators must be fully familiar.
	Indicates a high voltage hazard. If a particular safety check is not performed or the instrument is mishandled, this may give rise to a hazardous situation; the operator may receive an electric shock, may get burnt or may even be fatally injured.
	Indicates a strong magnetic-field hazard. The effects of the magnetic force can cause abnormal operation of heart pacemakers and/or medical electronics.
	Indicates prohibited actions.
	Indicates the action which must be performed.
*	Additional information is presented below.

Symbols affixed to the instrument

	Indicates cautions and hazards. When the symbol is printed on the instrument, refer to a corresponding topic in the Instruction Manual.
	Indicates that dangerous voltage may be present at this terminal.
	Indicates a double-insulated device.
	Indicates a fuse.
	Indicates a grounding terminal.
	Indicates DC (Direct Current).
	Indicates AC (Alternating Current).
	Indicates DC (Direct Current) or AC (Alternating Current).

Symbols for various standards

	Indicates the Waste Electrical and Electronic Equipment Directive (WEEE Directive) in EU member states.
	Indicates that the instrument conforms to regulations set out by the EC Directive.

Accuracy

We define measurement tolerances in terms of rdg. (reading) and dgt. (digit) values, with the following meanings:

rdg.	(Reading or displayed value) The value currently being measured and indicated on the measuring instrument.
dgt.	(Resolution) The smallest displayable unit on a digital measuring instrument, i.e., the input value that causes the digital display to show a "1" as the least-significant digit.

Measurement categories

To ensure safe operation of measuring instruments, IEC 61010 establishes safety standards for various electrical environments, categorized as CAT II to CAT IV, and called measurement categories.

DANGER



- **Using a measuring instrument in an environment designated with a higher-numbered category than that for which the instrument is rated could result in a severe accident, and must be carefully avoided.**
- **Using a measuring instrument without categories in an environment designated with the CAT II to CAT IV category could result in a severe accident, and must be carefully avoided.**

This instrument conforms to the safety requirements for CAT II 1000 V, CAT III 600 V measuring instruments.

- CAT II: When directly measuring the electrical outlet receptacles of the primary electrical circuits in equipment connected to an AC electrical outlet by a power cord (portable tools, household appliances, etc.)
- CAT III: When measuring the primary electrical circuits of heavy equipment (fixed installations) connected directly to the distribution panel, and feeders from the distribution panel to outlets
- CAT IV: When measuring the circuit from the service drop to the service entrance, and to the power meter and primary overcurrent protection device (distribution panel)

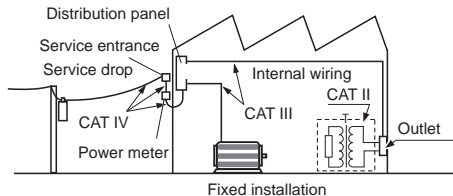

See: "2.3 Using Test Leads" (p. 26)

Usage Notes

Follow these precautions to ensure safe operation and to obtain the full benefits of the various functions.

DANGER

If the test lead or the instrument is damaged, there is a risk of electric shock. Before using the instrument, perform the following inspection.



- Before using the instrument, check that the coating of the test leads are neither ripped nor torn and that no metal parts are exposed. Using the instrument under such conditions could result in electrocution. Replace the test leads with those specified by our company.
- To avoid electric shock, check that the white or red portion (insulated layer) within the cable is not exposed. Do not use the cable if its internal colored portion is exposed.
- Before using the instrument the first time, verify that it operates normally to ensure that no damage occurred during storage or shipping. If you find any damage, contact your authorized Hioki distributor or reseller.

Installation

Installing the instrument in inappropriate locations may cause a malfunction of instrument or may give rise to an accident. Avoid the following locations.

For details on the operating temperature and humidity, see the specifications. (p. 51)

CAUTION

- Exposed to direct sunlight or high temperature
- Exposed to corrosive or combustible gases
- Exposed to water, oil, chemicals, or solvents
- Exposed to high humidity or condensation
- Exposed to a strong electromagnetic field or electrostatic charge
- Exposed to high quantities of dust particles
- Near induction heating systems (such as high-frequency induction heating systems and IH cooking equipment)
- Susceptible to vibration
- An unstable table or inclined surface



Using the instrument with the stand

CAUTION

- Do not position the instrument on an unstable table or inclined surface.
- When the instrument is set on the stand, do not apply a strong force above. Doing so may damage the stand.



Handling the cables

WARNING

To prevent electric shock, when measuring the voltage of a power line use a test lead that satisfies the following criteria:



- Conforms to safety standards IEC61010 or EN61010
- Of measurement category II or III
- Its rated voltage is higher than the voltage to be measured

All of the optional test leads for this instrument conform to the safety standard EN61010. Use a test lead in accordance with its defined measurement category and rated voltage.

CAUTION



- Avoid stepping on or pinching the cable, which could damage the cable insulation.
- To avoid damaging the cables, do not bend or pull the leads and the probe bases.



The ends of the test leads are sharp. Be careful to avoid injury.

For the test leads supplied with the instrument or the options to be connected to the instrument, see the following information.

Accessories and options	Reference
Test lead	"2.3 Using Test Leads" (p. 26)
Thermocouples (K)	"3.10 Measuring Temperatures (DT4212)" (p. 43)

Handling the strap

DANGER



Those with medical electronics such as pacemakers should not use the Z5004 Magnetic Strap. Nor should such persons approach the Z5004. It is extremely dangerous. The electronics may not operate properly and the life of the operator may be put at great risk.

CAUTION



- Do not use the Z5004 in locations where it may be exposed to rainwater, dust, or condensation. In those conditions, the Z5004 may be decomposed or deteriorated. The magnet adhesion may be diminished. In such case, the instrument may not be hung in place and may fall.
- Do not bring the Z5004 near magnetic media such as floppy disks, magnetic cards, pre-paid cards, or magnetized tickets. Doing so may corrupt and may render them unusable. Furthermore, if the Z5004 is brought near precision electronic equipment such as PCs, TV screens, or electronic wrist watches, they may fail.

Precautions during measurement

WARNING



If the instrument is used in locations where the rating indicated on the instrument or probes is exceeded, the instrument may be damaged resulting in personal injury. Do not use the instrument in such locations. See “Measurement categories” (p. 7).

- With regard to the 10 A range, the maximum input current is 10 A DC/10 Arms AC. Supplying a current in excess of the maximum input may damage the instrument and result in personal injury. Do not supply current in excess of the specified limit.

Observe the following to avoid electric shock and/or short circuits.



- Hazardous voltage may be generated in a free measurement terminal. Do not touch the free terminal.
- Use only test leads and optional equipment specified by our company.
- Do not allow the metal part of the test lead to touch any exposed metal, or to short between 2 lines. Never touch the metal end.
- When connecting the clip-type test lead to the active terminal, do not allow the lead to touch any exposed metal, or to short between 2 lines.

CAUTION



- Do not input voltage or supply current exceeding the specified measurement range. Doing so may damage the instrument.
- During the continuity check, diode test, or measurement of resistance or electrostatic capacity, measurement signals are generated in the terminals of the instrument. Depending on the target for measurement, the measurement signal may cause damage. Seeing “Measurement current” and “Open circuit voltage” in the accuracy table (p. 55), check, in advance, that there are no adverse effects of the measurement current and the open circuit voltage.

Precautions during shipment

Observe the following during shipment. Hioki cannot be responsible for damage that occurs during shipment.

CAUTION



- During shipment of the instrument, handle it carefully so that it is not damaged due to a vibration or shock.
- To avoid damage to the instrument, remove the accessories and optional equipment from the instrument before shipment.

If the instrument is not to be used for an extended period of time

IMPORTANT

To avoid corrosion and/or damage to the instrument due to battery leakage, remove the batteries from the instrument if it is to be kept in storage for an extended period.

1

Overview

1.1 Overview and Features

This instrument is a multi-function digital multimeter that performs measurement functions for items such as voltage, current, resistance, and capacity.

Main features and functions

- Large display on which the measured values can be read easily
- Environmental performance (can be used anywhere) (Operation temperature: -10 to 50°C (14°F to 122°F))
- Display hold (HOLD)
- Low power consumption for an extended time

Problem finding a suitable installation location?

The strap with magnet allows the instrument to be hung conveniently.

For various purposes

The measurement test leads and end pins can be selected.

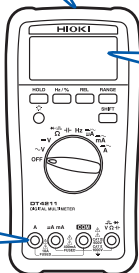
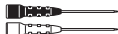

Large display of values

Backlighting to allow users to read the measurement values in dark environments



1.2 Parts Names and Functions

Front

Some indications are different between the DT4211 (Average value measurement model) and DT4212 (True RMS measurement model)

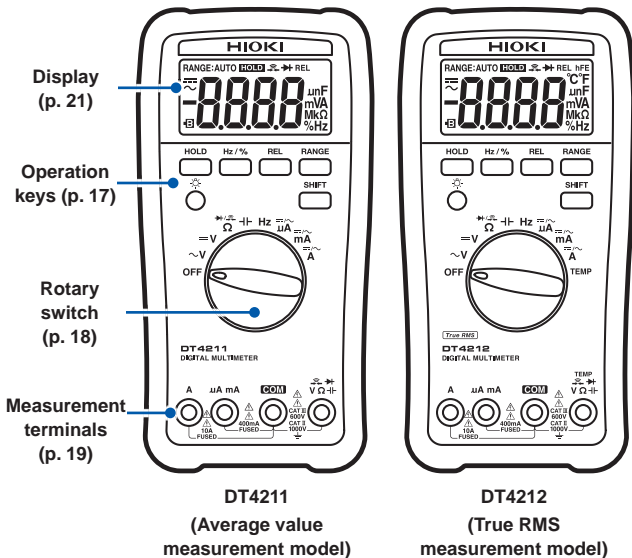

Operation keys

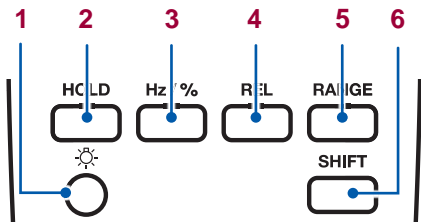

1		Backlight key Turns on/off the backlight. (p. 49)
2	HOLD	Manually sets/cancels the hold function for the displayed value. (HOLD lights up/goes off.) (p. 46)
3	Hz/%	Switches the frequency (p. 39) and duty ratio (p. 40) display.
4	REL	Displays the relative value (REL). (p. 47) ([REL] lights up/goes off.)
5	RANGE	Sets the manual range and switches the range. (p. 45) (Turns on/off the [RANGE:AUTO]) Cancels the manual range. (Pressed down for at least 1 second.)
6	SHIFT	Switches the function. Cancels the auto power save function (APS). (Power-on option)

Rotary switches and measurement descriptions

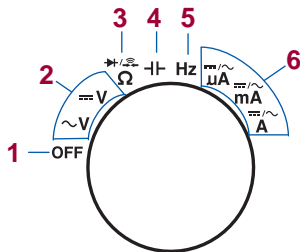

DT4211
(Average value
measurement model)

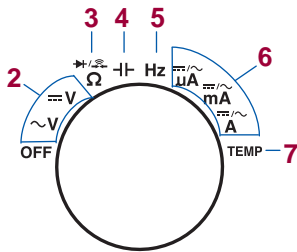

DT4212
(True RMS
measurement model)

Function		DT4211	DT4212
1	OFF		
2	$\sim V$ AC voltage and frequency measurement $\equiv V$ DC voltage measurement	√	√
		√	√
3	Ω Resistance measurement Diode test Continuity check	√	√
	Diode test Continuity check	√	√
	Continuity check	√	√
4	Electrostatic capacity	√	√
5	Hz Frequency and duty ratio measurement	√	√
6	$\equiv/\sim \mu A$ DC (μA) measurement/AC (μA) measurement $\equiv/\sim mA$ DC (mA) measurement/AC (mA) measurement $\equiv/\sim A$ DC (A) measurement/AC (A) measurement	√	√
	$\equiv/\sim mA$ DC (mA) measurement/AC (mA) measurement $\equiv/\sim A$ DC (A) measurement/AC (A) measurement	√	√
	$\equiv/\sim A$ DC (A) measurement/AC (A) measurement	√	√
7	TEMP Temperature measurement	-	√

Measurement terminals

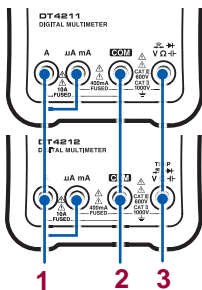

DT4211
(Average value measurement model)

DT4212
(True RMS measurement model)

-
- 1** Current measurement terminal.
Hereafter referred to as “A terminal (μA terminal, mA terminal)”.
The red test lead is connected.

 - 2** Commonly used for each measurement.
Hereafter referred to as “COM terminal”.
The black test lead is connected.

 - 3** Used for voltage measurement, resistance measurement, continuity check, diode test, temperature measurement, or electrostatic capacity measurement.
Hereafter referred to as “V terminal”.
The red test lead is connected.

Be sure to carefully read the following precautions for the terminals with the  marking.

- “Precautions during shipment” (p. 13)
- “6.3 Replacing Fuses” (p. 67)

Rear

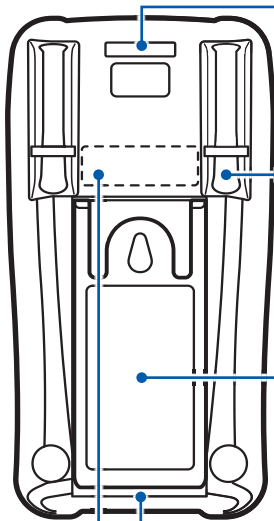

Strap hole

The optional Z5004 Magnetic Strap can be attached.

Test lead holder

The test lead can be held.

Stand

The instrument can be set on the stand.



Serial number label

It is necessary for production control such as product warranty. Do not peel off the label. Before checking the serial number, remove the holster.

Battery cover

When replacing the batteries (p. 24) or fuse (p. 67), remove the cover.

⚠ See p. 24.

1.3 Display

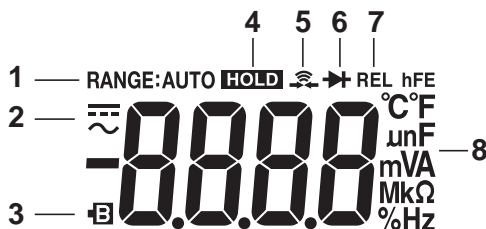

1	RANGE:AUTO	Auto range (p. 45)
2	\approx	DC, AC
3	B	Battery warning indicator Lights up when the battery voltage falls below the voltage at which accuracy is guaranteed ($2.4 \text{ V} \pm 0.15 \text{ V}$).
4	HOLD	Retention of the measured value. (p. 46)
5	$\text{}$	Continuity check (p. 37)
6	$\text{}$	Diode (p. 36)
7	REL	Relative value display (p. 47)
8	Each measurement unit	

2

Preparation for Measurements

2.1 Measurement Workflow

Before using the instrument, be sure to read “Usage Notes” (p. 8).

Installation and connection

Insert the batteries. (p. 24)

Perform the startup check. (p. 29)

As necessary, have other optional items available and ready.

Measurement

Turn on the power and select the measurement function.

Attach the test leads to the measurement terminals. (p. 26)
(As necessary, perform zero adjustment. (p. 48))

Connect the test leads to the measurement object.

(As necessary)

Hold the display of the measured value. (p. 46)

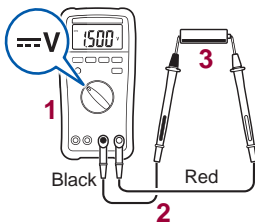

To ensure safe operation, make sure to select a measurement function and then connect the test leads to the measurement object.

End of the measurement

Move the test leads away from the measurement object and then turn off the power.

2.2 Inserting/Replacing Batteries

Before using the instrument for the first time, insert 2 R6P manganese batteries or LR6 alkaline batteries. Before measurements, check that the battery level is sufficient. When the battery charge is low, replace the batteries.

WARNING



To avoid electric shock, disconnect the test leads from the object to be measured before replacing the batteries.



To avoid the possibility of explosion, do not short circuit, charge, disassemble, or incinerate batteries.



After battery replacement but before using the instrument, reattach and screw down the battery cover.

CAUTION

Poor performance or damage from battery leakage could result. Observe the cautions listed below.



- Do not mix new and old batteries, or different types of batteries.
- Be careful to observe the battery polarity during installation.
- Do not use batteries after their recommended expiry date.
- Do not allow used batteries to remain in the instrument.



- To avoid corrosion from battery leakage and/or damage to the instrument, remove the batteries from the instrument if it is to be kept in storage for an extended period.

- **B** lights up when the batteries are exhausted. The accuracy is not guaranteed. Replace the battery immediately.
- After use, be sure to turn off the instrument.
- Handle and dispose of batteries in accordance with local regulations.

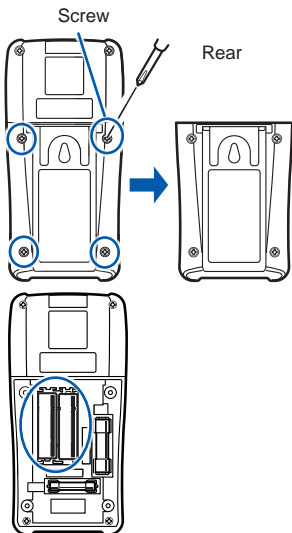
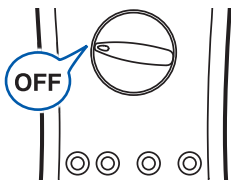

- 1 **Have the following items available and ready.**
 - Phillips screwdriver
 - R6P manganese battery x 2 or LR6 alkaline battery x 2
- 2 **Remove the test leads from the instrument.**
- 3 **Set the rotary switch to OFF.**
- 4 **Remove the holster.**
- 5 **Using a Phillips screwdriver remove the screws (4 locations) from the battery cover on the rear of the instrument.**
- 6 **Remove the battery cover.**
- 7 **Remove all of the old batteries.**
- 8 **Insert 2 new batteries (R6P), being careful to the battery polarity.**
- 9 **Reattach the battery cover.**
- 10 **Secure the cover with the screw.**
- 11 **Reattach the holster.**

After the battery cover is removed, the fuse can be seen. When replacing the fuse, see “6.3 Replacing Fuses” (p. 67).

2.3 Using Test Leads

The L9206 Test Leads supplied with the instrument are used for measurements.

Depending on measurement locations, use our optional measurement cables. For details on the optional items, see “Options (sold separately)” (p. 2).

DANGER



To avoid electric shock, do not short circuit the line on which voltage is applied at the tip of the test lead.

WARNING



- To prevent a short circuit accident, be sure to use the test leads with the sleeves attached when performing measurements in the CAT III measurement category. (See “Measurement categories” (p. 7))
- If the sleeves are inadvertently removed during measurement, stop the measurement.
- When connecting the lead, use the correct voltage measurement terminal (V terminal) and current measurement terminal (A terminal). If an incorrectly connected lead is used, the instrument may be damaged or short circuit accidents may occur.
- Use only test leads and optional equipment specified by our company.

CAUTION



- To ensure safe operation, use only test leads specified by our company.
- When carrying out measurements with the sleeves in place, be careful to avoid damaging the sleeves.
- The tips of the metal pins are sharp and may cause injury. Do not touch the tips.

L9206 Test Lead

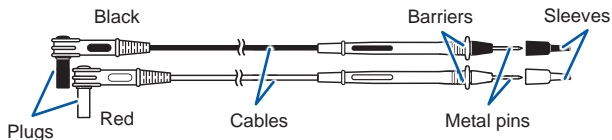

Metal pin Connect to the object to be measured.
 4 mm or less (sleeve attached)
 19 mm or less (sleeve removed)
 Diameter ϕ approx. 2 mm

Sleeve Attach to the metal pins to prevent short circuit accidents.

Barrier Represents the safe handling distance from the metal pins.

During measurement, do not touch the area between the barrier and the tip of the sleeve.

Plug Connect to the measurement terminals on this instrument.

Cable Double sheathed cables (Length: approx. 980 mm, Diameter: ϕ approx. 3.5 mm)

When the white portion inside the cable is exposed, replace with a new L9206 Test Lead.

Removing and attaching the sleeves

Removing the sleeves

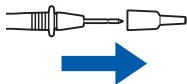

Gently hold the bottom of the sleeves and pull the sleeves off. Safely store the removed sleeves so as not to lose them.

Attaching the sleeves

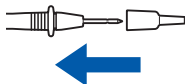

Insert the metal pins of the test leads into the holes of the sleeves, and firmly push them all the way in.

Connecting to the instrument

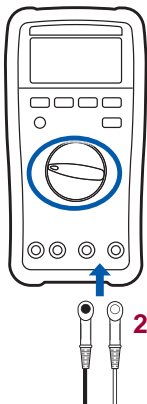

- 1 Turn the rotary switch to the desired measurement function.
- 2 Connect the test leads to the relevant measurement terminals.

- Except the current measurement

COM terminal Connect the black test lead.
V terminal Connect the red test lead.

- Current measurement

COM terminal Connect the black test lead.
 $\mu\text{A}/\text{mA}$ terminal Connect the red test lead.
A terminal

3

Performing Measurements

3.1 Inspection Before Use

Before using the instrument the first time, verify that it operates normally to ensure that no damage occurred during storage or shipping. If you find any damage, contact your authorized Hioki distributor or reseller.

Appearance check of the instrument and test leads

Check item	Action
The instrument is neither damaged nor cracked. The internal circuits are not exposed.	Visually check the instrument. If it is damaged, there is a risk of electric shock. Do not use the instrument but send it for repair.
The terminals are not contaminated with debris.	Remove contamination with a cotton swab.
The coating of the test leads is neither broken nor frayed, or the white portion or metal part within the lead is exposed.	If the test lead is damaged, there is a risk of electric shock. Do not use the instrument but send it for repair.

Check when turning on the power

(Set the rotary switch to any position other than OFF.)

Check item	Action
The battery voltage is sufficient.	When  appears at the left bottom of the display, the battery voltage is low. The accuracy is not guaranteed. Replace the battery immediately.

Operation check

This section introduces some of the operation checks. Periodical calibration is necessary in order to ensure that this instrument operates according to its specifications.

7 Check that the test leads are not broken.

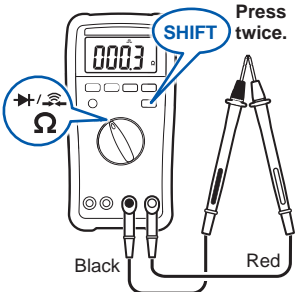
Check method	Action
<p>Regarding the continuity check, deliberately short circuit the test leads and then check the display.</p> 	<p>Normal: A buzzer sounds and the value stabilizes at around 0Ω.</p> <p>Abnormal: A buzzer does not sound and a numeric value other than the above appears.</p> <p>Corrective action: The test leads may be broken. Replace with those specified by our company. If the same phenomena persist even after the test leads are replaced, a malfunction may occur. Halt inspection and then send the instrument for repair.</p>

2 Measure samples (such as battery, commercial power supply, and resistor) of which values have already been known, and check that the appropriate values appear.

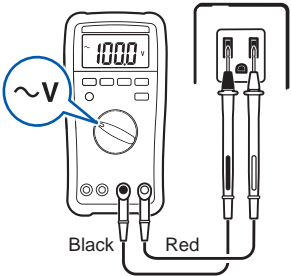
Check method	Action
<p>Example: Perform the AC voltage measurement to measure the commercial power supply, and then check the display.</p> 	<p>Normal: An already-known value appears. (In this example, the commercial voltage level should appear.)</p> <p>Abnormal: The measured value does not appear. The malfunction may occur. Stop the inspection and do not use the instrument.</p>

3 Check that the fuse is not broken.

Check method	Action							
1. Remove the fuse from the instrument. (p. 67) 2. Reattach the battery cover. 3. In the resistance measurement, check the resistance of the fuse. (Resistance measurement (p. 35))	<p>Normal:</p> <table border="1" data-bbox="526 282 909 428"> <thead> <tr> <th data-bbox="526 282 707 326">Fuse rating</th> <th data-bbox="707 282 909 326">Resistance</th> </tr> </thead> <tbody> <tr> <td data-bbox="526 326 707 369">630 mA</td> <td data-bbox="707 326 909 369">Approx. 1.0Ω</td> </tr> <tr> <td data-bbox="526 369 707 428">10 A</td> <td data-bbox="707 369 909 428">Approx. 0.1Ω</td> </tr> </tbody> </table> <p>Abnormal: If the value above is not obtained (the value higher than that is displayed), replace the fuse. (p. 67)</p>		Fuse rating	Resistance	630 mA	Approx. 1.0Ω	10 A	Approx. 0.1Ω
Fuse rating	Resistance							
630 mA	Approx. 1.0Ω							
10 A	Approx. 0.1Ω							

Before measurements

WARNING

Observe the following to avoid short circuit accidents.

- Always verify the appropriate setting of the rotary switch before connecting the test leads.
- Disconnect the test leads from the measurement object before switching the rotary switch.
- Operate or connect the instrument by following the procedure of each measurement example (or procedure steps).



3.2 Measuring Voltage

The AC/DC voltage can be measured. Furthermore, the AC frequency and duty ratio can be checked.

Before measurements

WARNING



If the instrument is used in locations where the rating indicated on the instrument or probes is exceeded, the instrument may be damaged resulting in personal injury. Do not use the instrument in such locations. See “Measurement categories” (p. 7).

The autoranging function of this instrument automatically selects the optimum measurement range. To change the range arbitrarily, use the manual range. (p. 45)

Measuring AC voltage

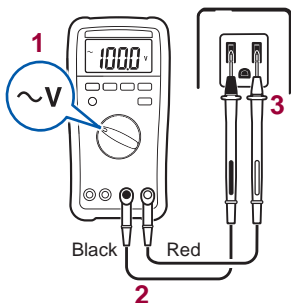

The AC voltage is measured. The measured value is an average rectifying RMS indication (DT4211) or true RMS indication (DT4212). (p. Appx.1)

When the **Hz/%** key is pressed, the frequency and duty ratio can be measured. (p. 40)

Measuring DC voltage

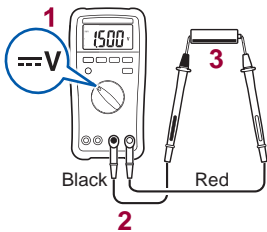

Measure the DC voltage.

3.3 Measuring Resistance

Resistance is measured.

WARNING



Before measuring, be sure to turn off the power to the measurement circuit. Otherwise, electric shock may occur or the instrument may be damaged.

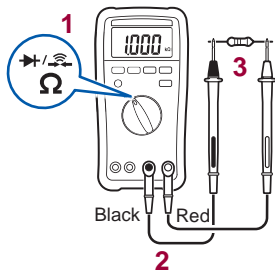

The open terminal voltage is approx. 0.5 V or less. The measurement current (DC) varies depending on the range. To avoid damage to the measurement object, check the specifications before use.

3.4 Measuring Diode

The forward voltage of the diode is measured.

If the forward voltage is within the range from 0 V to 1 V, the forward voltage is displayed.

⚠ WARNING



Before measuring, be sure to turn off the power to the measurement circuit. Otherwise, electric shock may occur or the instrument may be damaged.

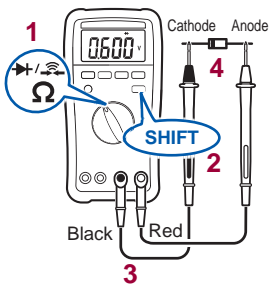

In the case of the opposite connection



The open terminal voltage is approx. 3.0 V or less.
To avoid damage to the measurement object, check the specifications of the measurement object before use.

3.5 Checking Continuity

The input short circuit is detected and informed via a buzzer.

! WARNING



Before measuring, be sure to turn off the power to the measurement circuit. Otherwise, electric shock may occur or the instrument may be damaged.

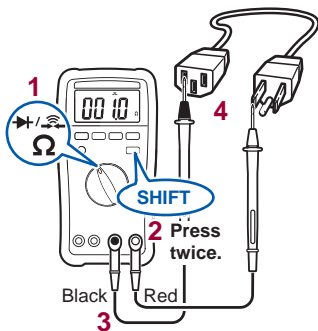

A buzzer sounds during continuity (short circuit detection), and the resistance is displayed. (400Ω range fixed)

Detection	Threshold	Buzzer
Short circuit detection	$90\Omega \pm 40\Omega$ or less	Sounds (continuous buzzer sound)

3.6 Measuring Electrostatic Capacities

The capacity of the capacitor is measured.

WARNING



Before measuring, be sure to turn off the power to the measurement circuit. Otherwise, electric shock may occur or the instrument may be damaged.



Do not measure the capacitor which has been charged.

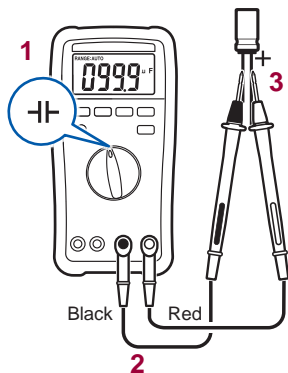

- **When measuring the polar capacitor**
Connect the V terminal (red test lead) to the + terminal of the capacitor and the COM terminal (black test lead) to the - terminal.
- For components on a circuit board, measurement may not be possible due to the effect of the peripheral circuit.

3.7 Measuring Frequencies

The frequency of the measured signal (square wave) is also measured. The frequency display is auto-ranging.

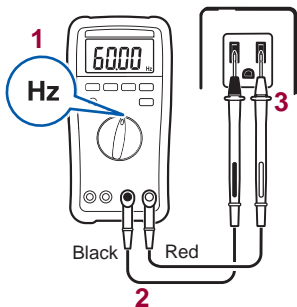

When measuring frequencies of AC voltage and AC current

For the AC voltage measurement, use the ACV setting, and for the AC current measurement, use the AC μ A, ACmA, or ACA setting. The frequency can be checked by pressing the Hz/% key ([Hz] lights up). The voltage (current) range is fixed to the range before the Hz/% key is pressed.

- If signals out of the range of frequency measurement are measured, the display becomes unstable. Be aware of this point.
- The sensitivity of the frequency measurement is regulated by range. (Minimum sensitivity voltage (p. 58)
When the value is less than the minimum sensitivity voltage (current), the indicated value may fluctuate. When the voltage (current) range is lowered, the value stabilizes. This does not apply to cases where the value fluctuates due to noise.
- During the measurement of low frequency voltage (current), if the auto range does not stabilize and the frequency cannot be measured, change the voltage (current) range and measure again.

3.8 Measuring Duty Ratio

The duty ratio (or duty factor) indicates the ratio of the pulse width and pulse repetition frequency. The instrument displays the ratio as a percentage (%).

Duty ratio for the plus slope (D+): $D+ = tw+/T \times 100$ (%)

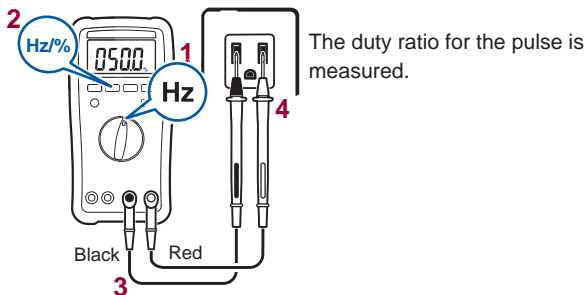
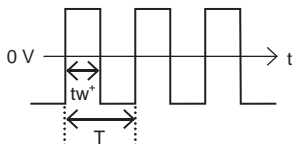

When measuring duty ratio of AC voltage and AC current

For the AC voltage measurement, use the ACV setting, and for the AC current measurement, use the AC μ A, ACmA, or ACA setting. The duty ratio can be checked by pressing the **Hz/%** key twice. The voltage (current) range is fixed to the range before the **Hz/%** key is pressed.

3.9 Measuring Current

DC/AC is measured. DC and AC are switched with the **SHIFT** key.

DANGER



- Do not input any voltage to the current measurement terminals. Doing so may result in short circuit accidents.
- To avoid electrical accidents, turn off the power to the circuit before measuring and then connect the test leads.

Measuring DC/AC

Function

- **μA** Selected to measure 4000 μA DC/AC or less.
- **mA** Selected to measure 400.0 mA DC/AC or less.
- **A** Selected to measure 10 A DC/AC or less.

When measuring an unknown current

Set to the high range.

Measuring with the μA range

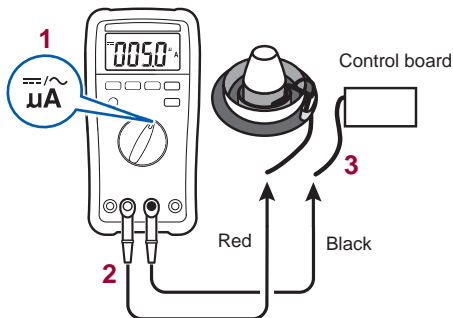

Example: Measuring the current of the burner flame (μA)

The measured current value of the burner flame varies with the input impedance of the instrument.
The μA input impedance of this instrument is approx. 100Ω .

Measuring with the A range

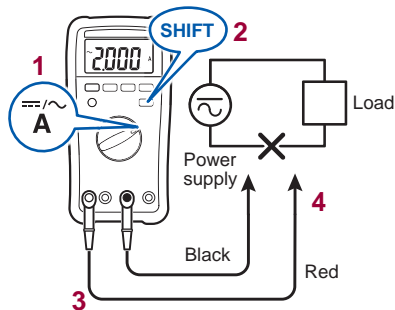

3.10 Measuring Temperatures (DT4212)

Using our optional DT4910 Thermocouples (K), temperatures can be measured.

! CAUTION



To avoid damage to the instrument, do not input any voltage or supply current to the thermocouple.

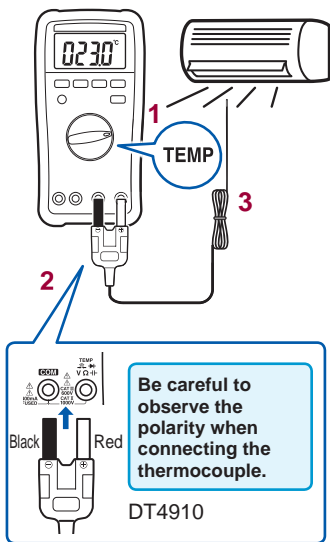

Checking the temperature change

It can be checked in the relative value display. (p. 47)

When measuring temperatures with the thermocouple applied to the surface of the measurement object

Clean the surface so that the thermocouple can make contact with the object securely.

If temperature is not measured after the thermocouple is attached

The instrument or thermocouple may be malfunctioning. Check this with the following procedure.

Short-circuit the V terminal of the instrument using the test leads.

The ambient temperature is displayed.

The thermocouple may be malfunctioning (blown).
Replace the thermocouple with a new one.

The ambient temperature is not displayed.

The instrument is malfunctioning.
Send it for repair.

4

Using Instrument Conveniently

4.1 Selecting the Measurement Range

Auto or Manual range can be selected.

- Auto range Sets the optimum range automatically in accordance with the actual measurement.
- Manual range Sets the specific range manually.

Measuring with the auto range



[RANGE: AUTO] lights up.

When the measurement function is switched using the rotary switch, the auto range is enabled.

Measuring with the manual range



Press the **RANGE** key.

[RANGE: MANUAL] lights up.

Each time the **RANGE** key is pressed, a higher range is specified. When the key is pressed at the highest range, the lowest range is specified once again.

Example: When the range is 400.0 mV to 1000 V

400.0 mV → 4.000 V → 40.00 V → 400.0 V
→ 1000 V → 400.0 mV

To switch from the manual range to the auto range, press the **RANGE** key for at least 1 second.

4.2 Retaining the Measured Value

When **HOLD** is pressed, the measured value is retained. (HOLD lights up.)

Retaining the measured value (HOLD)



To retain the measured value, press the **HOLD** key.

(HOLD lights up and the measurement value is retained.)

To cancel the hold state, press it again.
(HOLD goes off.)

4.3 Checking the Relative Value/ Performing Zero Adjustment

The relative value comparing to the standard value can be checked (relative function).

It can also be used as the zero adjustment function.

Zero adjustment eliminates the influences of the test lead wiring resistance (continuity, resistance measurement) and the wiring capacity (capacitor measurement).

This function is disabled under the following conditions.

During OL display, frequency measurement, and duty measurement

Checking the relative value (REL)

Example: DC voltage measurement



When the standard value is measured, press **REL** for at least 1 second.

(**REL** lights up.)

The relative value is displayed.
To cancel the display, press it again.
(**REL** goes off.)

- When the relative function is performed, the auto range is canceled. (However, this excludes the capacity measurement function.)
- Do not input values exceeding 4000 counts for the DC voltage, DC current, and temperature measurement (only the DT4212).

Performing zero adjustment

When performing zero adjustment, the condition of the test leads varies depending on the measurement function.

Perform zero adjustment, referring to the table below.

Measurement function	V, Ω , μ , A	- +
Condition of the test leads	Short circuit	Open

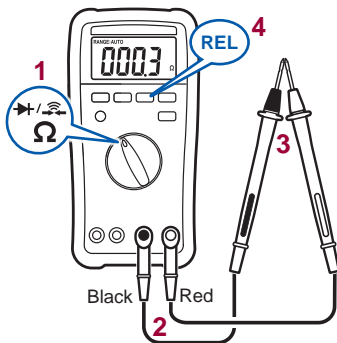

Example 1: Resistance measurement

- 1 Select the measurement function.
- 2 Connect the test leads to the measurement terminals.
- 3 Allow the test leads to short circuit.
- 4 Press the **REL** key.
(After zero adjustment: 0.0Ω)
- 5 Measure the resistance.

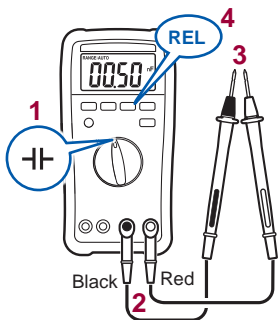

Example 2: Capacitor measurement

- 1 Select the measurement function.
- 2 Connect the test leads to the measurement terminals.
- 3 Allow the test leads to open.
- 4 Press the **REL** key.
(After zero adjustment: 0.00 nF)
- 5 Measure the capacitor.

4.4 Turning On the Backlight

The backlight can be turned on/off by pressing the backlight key.

The backlight automatically turns off if the instrument is not operated for approx. 80 seconds.

4.5 Using the Auto Power Save (APS)

The auto power save function saves on battery consumption. If the instrument has not been operated for approx. 30 minutes, it enters the sleep mode.

In the default setting, the auto power save function is set to enabled.

To continuously use the instrument, press any key or turn the rotary switch.

Auto power save function

- When the instrument is in the sleep mode, press any key or turn the rotary switch to recover from the sleep mode.
- If the instrument will be used for an extended period of time, disable the auto power save function.
- After use, set the rotary switch to OFF. The sleep mode consumes a small amount of current.

Canceling the auto power save function (APS)

While pressing the **SHIFT** key, turn the rotary switch.

5

Specifications

5.1 General Specifications

Power supply	R6P manganese battery × 2 or LR6 alkaline battery × 2
Battery indicator warning voltage	 lights up when 2.4 V ± 0.15 V or less
Dimensions	Approx. 91.6 W × 180.6H × 57.1 D mm (3.61" W × 7.11" H × 2.25" D) (including the holster)
Mass	Approx. 388 g (13.7 oz.) (including the batteries and holster)
Operating environment	Indoors, pollution degree 2, altitude up to 2000 m (6562-ft.)
Operating temperature and humidity	<ul style="list-style-type: none">• Temperature -10°C to 50°C (14°F to 122°F) (However, 0°C to 50°C (32°F to 122°F) for the temperature function)• Humidity 0°C to 40°C (32°F to 104°F): 80% RH or less (non-condensating) 40°C to 45°C (104°F to 113°F): 60% RH or less (non-condensating) 45°C to 50°C (113°F to 122°F): 50% RH or less (non-condensating)• Humidity (40MΩ range) 0°C to 30°C (32°F to 86°F) : 80% RH or less (non-condensating) 30°C to 40°C (86°F to 104°F) : 70% RH or less (non-condensating) 40°C to 45°C (104°F to 113°F) : 60% RH or less (non-condensating) 45°C to 50°C (113°F to 122°F) : 50% RH or less (non-condensating)
Storage temperature and humidity	-20°C to 60°C (-4°F to 140°F), 80% RH or less (non-condensating)

Dustproof and waterproof	IP40 (EN60529)
Product warranty period	3 years (excluding the measurement accuracy)
Accessories	<ul style="list-style-type: none">• L9206 Test Lead• Holster (attached to the instrument, with a test lead holder)• Instruction Manual• R6P manganese battery × 2 (not installed in the instrument)
Options	See: "Options (sold separately)" (p. 2)
Replacement parts	630 mA/1000 V fuse for current terminal (μ A, mA) (Breaking capacity 50 kA Fast-blow type: ϕ 6.3 × 32 mm, SIBA) 10 A/1000 V fuse for current terminal (A) (Breaking capacity 30 kA Fast-blow type: ϕ 10 × 38 mm, SIBA)
Applicable standards	<ul style="list-style-type: none">• Safety: EN61010• EMC: EN61326

5.2 Electrical Characteristics

Noise suppression NMRR	<ul style="list-style-type: none"> • DCV: -45 dB or more (50 Hz/60 Hz)
Noise suppression CMRR	<ul style="list-style-type: none"> • DCV: -100 dB or more (DC/50 Hz/60 Hz, 1kΩ unbalance) • ACV: -60 dB or more (DC/50 Hz/60 Hz, 1kΩ unbalance) (However, -45 dB or more for the 1000 V range)
Response time (Auto range)	<ul style="list-style-type: none"> • DCV: 1.2 to 1.4 seconds (0 V \rightarrow 100 V auto range operation) • ACV: 0.7 to 0.9 seconds (0 V \rightarrow 100 V auto range operation) • Ω: 1.2 to 1.4 seconds (Infinity \rightarrow 0Ω auto range operation)
Display update rate	<p>Measured value:</p> <p>3 times/s (after the range is fixed, excluding the resistance, continuity, electrostatic capacity, frequency)</p> <p>2 times/s (resistance, continuity)</p> <p>0.5 to 2 times/s (varies depending on the electrostatic capacity)</p> <p>5 times/s (frequency)</p>
Dielectric strength	Between the measurement terminal and case 7.06 kV AC sine wave (50 Hz/60 Hz, 60 seconds)
Maximum rated voltage between terminals	V terminal: 1000 V DC/AC or 10 ⁶ V \cdot Hz
Maximum rated current between terminals	Current terminal (A): 10 A DC/10 A AC Current terminal (μ A, mA) 400 mA DC/400 mA AC
Maximum rated voltage between input terminals and ground	1000 V AC (Measurement category II) 600 V AC (Measurement category III) Anticipated transient overvoltage: 6000 V

Rated power voltage	1.5 V DC × 2 R6P manganese battery × 2 LR6 alkaline battery × 2
Maximum rated power	100 mVA (max) Power voltage 3.0 V, continuity measurement input short-circuited, backlight lit
Rated power	<ul style="list-style-type: none"> • 7.5 mVA +20% or less Power voltage 3.0 V, DCV measurement, backlight off • 0.05 mVA +20% or less Power voltage 3.0 V, auto power save function activated
Continuous operating time	AA manganese batteries, DCV, backlight off DT4211 (Average value measurement model): Approx. 300 hours DT4212 (True RMS measurement model): Approx. 240 hours AA alkaline batteries, DCV, backlight off DT4211 (Average value measurement model): Approx. 800 hours DT4212 (True RMS measurement model): Approx. 450 hours

5.3 Accuracy Table

Accuracy warranty period	1 year
Regulated power supply range	2.4 V \pm 0.15 V or more (until B lights up)
Accuracy guarantee for temperature and humidity	23°C \pm 5°C (73°F \pm 9°F), 80%RH or less (non-condensating)
Temperature characteristic	Adds "Measurement accuracy \times 0.1/°C" (excluding 23°C \pm 5°C (73°F \pm 9°F)).

- rdg. (reading or displayed value): The value currently being measured and displayed on the measuring instrument.
- dgt. (resolution): The smallest displayable unit, i.e., the input value that causes the digital display to show a "1" as the least-significant digit.

7 AC voltage

Range	Accuracy ¹	Input impedance
	40 to 500 Hz	
400.0 mV ²	\pm 1.0% rdg. \pm 10 dgt.	11M Ω \pm 2%
4.000 V	\pm 1.0% rdg. \pm 5 dgt.	100 pF or less
40.00 V	\pm 1.0% rdg. \pm 5 dgt.	10M Ω +2% 100 pF or less
400.0 V		
1000 V		

- Overload protection: 1100 V DC/1100 V AC or 10⁶ V • Hz (energized for 1 minute)
Transient overvoltage: 6000 V
- Crest factor (Only the DT4212 (True RMS measurement model)): The crest factor is 2 up to 2800 counts and reduces linearly to 1.5 at 4000 counts.

*1: The accuracy is specified in 1% or more of the range.

*2: Only the manual range.

2 DC voltage

Range	Accuracy	Input impedance
400.0 mV	±0.5% rdg. ±3 dgt.	Over 100MΩ
4.000 V		11MΩ ±2%
40.00 V	±0.5% rdg. ±3 dgt.	10MΩ +2%
400.0 V		
1000 V		

- Overload protection: 1100 V DC/1100 V AC or 10^6 V • Hz (energized for 1 minute)

3 Resistance

Range	Accuracy	Measurement current	Open circuit voltage
400.0Ω	±0.5% rdg. ±3 dgt.	Approx. 140 μA	0.5 V DC or less
4.000kΩ	±0.5% rdg. ±2 dgt.		
40.00kΩ	±0.5% rdg. ±2 dgt.	Approx. 40 μA	
400.0kΩ		Approx. 4 μA	
4.000MΩ		Approx. 400 nA	
40.00MΩ	±1.5% rdg. ±3 dgt.	Approx. 40 nA	

- Overload protection: 1000 V DC/1000 V AC or 10^6 V • Hz (energized for 1 minute)
Current under short circuit: 300 μA or less
Current under overload: Steady state 15 mA or less, transient state 0.8 A or less
- Maximum capacity load: 10 mF
- Maximum inductive load: 10 H

4 Diode

Range	Accuracy	Measurement current	Open circuit voltage
1.000 V	$\pm 10.0\%$ rdg.	0.5 mA	3.0 V DC or less Voltage drop due to battery consumption

- Overload protection: 1000 V DC/1000 V AC or 10^6 V • Hz (energized for 1 minute)
Current under short circuit: 0.7 mA or less
Current under overload: Steady state 15 mA or less, transient state 0.8 A or less

5 Continuity

Range	Accuracy	Measurement current	Open circuit voltage
400.0 Ω	$\pm 1.0\%$ rdg. ± 15 dgt.	Approx. 140 μ A	0.5 V DC or less

- Overload protection: 1000 V DC/1000 V AC or 10^6 V • Hz (energized for 1 minute)
Current under short circuit: 300 μ A or less
Current under overload: Steady state 15 mA or less, transient state 0.8 A or less
- Continuity ON threshold: $90 \pm 40\Omega$ or less (buzzer)
- Response time: Open circuit or short circuit is detected for at least 0.5 ms.

6 Electrostatic capacity

Range	Accuracy	Charging current	Open circuit voltage
50.00 nF	±1.5% rdg. ±15 dgt.	Approx. 30 µA	1.5 V DC or less
500.0 nF	±2.0% rdg. ±5 dgt.		
5.000 µF	±5.0% rdg. ±5 dgt.		
50.00 µF			
100.0 µF			

- Overload protection: 1000 V DC/1000 V AC or 10^6 V • Hz (energized for 1 minute)
Current under short circuit: 50 µA or less
Current under overload: Steady state 15 mA or less, transient state 0.8 A or less
- Accuracy guarantee condition: After REL (zero adjustment) has been performed

7 Frequency

Range	Accuracy	Minimum sensitivity voltage
5.000 Hz	±0.1% rdg. ±3 dgt.	Square wave of 1.5 Vrms or more
50.00 Hz		
500.0 Hz		
5.000 kHz		
50.00 kHz		
500.0 kHz	±0.1% rdg. ±3 dgt.	Square wave of 2.0 Vrms or more
5.000 MHz		

- Measurement range: 1 Hz or more

8 DC (μA)

Range	Accuracy	Input impedance
400.0 μA	$\pm 1.2\%$ rdg. ± 3 dgt.	100 Ω $\pm 5\%$
4000 μA		

- Overload protection: 630 mA/1000 V fuse, breaking capacity 50 kA

9 AC (μA)

Range	Accuracy ^{*1}	Input impedance
400.0 μA	$\pm 1.2\%$ rdg. ± 5 dgt.	100 Ω $\pm 5\%$
4000 μA		

- Overload protection: 630 mA/1000 V fuse, breaking capacity 50 kA
- Crest factor (only the DT4212 (True RMS measurement model)): The crest factor is 2 up to 2800 counts and reduces linearly to 1.5 at 4000 counts.

*1: The accuracy is specified in 1% or more of the range.

Accuracy guarantee range for frequency: 40 Hz to 500 Hz (Measured values outside the accuracy guarantee range for frequency are also displayed.)

10 DC (mA)

Range	Accuracy	Input impedance
40.00 mA	$\pm 1.2\%$ rdg. ± 3 dgt.	2 Ω $\pm 40\%$
400.0 mA		

- Overload protection: 630 mA/1000 V fuse, breaking capacity 50 kA

11 AC (mA)

Range	Accuracy ^{*1}	Input impedance
40.00 mA	±1.2% rdg. ±5 dgt.	2Ω ±40%
400.0 mA		

- Overload protection: 630 mA/1000 V fuse, breaking capacity 50 kA
- Crest factor (only the DT4212 (True RMS measurement model)): The crest factor is 2 up to 2800 counts and reduces linearly to 1.5 at 4000 counts.

*1: The accuracy is specified in 1% or more of the range.

Accuracy guarantee range for frequency: 40 Hz to 500 Hz (Measured values outside the accuracy guarantee range for frequency are also displayed.)

12 DC (A)

Range	Accuracy	Input impedance
4.000 A	±1.2% rdg. ±3 dgt.	0.05Ω ±40%
10.00 A		

- Overload protection: 10 A/1000 V fuse, breaking capacity 30 kA

13 AC (A)

Range	Accuracy ^{*1}	Input impedance
4.000 A	±1.2% rdg. ±5 dgt.	0.05Ω ±40%
10.00 A		

- Overload protection: 10 A/1000 V fuse, breaking capacity 30 kA
- Crest factor (only the DT4212 (True RMS measurement model)): The crest factor is 2 up to 2800 counts and reduces linearly to 1.5 at 4000 counts.

*1: The accuracy is specified in 1% or more of the range.

Accuracy guarantee range for frequency: 40 Hz to 500 Hz (Measured values outside the accuracy guarantee range for frequency are also displayed.)

14 Temperature

Thermocouple type	Range	Measurement range	Accuracy ^{*1}
K	400.0°C	-55.0°C to 0.0°C (-67°F to 32°F)	±2.0% rdg. ±2°C (±(T-32)×0.02±3.6°F)
		0.0°C to 50.0°C (32°F to 122°F)	±2°C (±3.6°F)
		50.0°C to 400.0°C (122°F to 752°F)	±2.0% rdg. ±1°C (±(T-32)×0.02±1.8°F)
	700°C	400°C to 700°C (752°F to 1292°F)	±2.0% rdg. ±1°C (±(T-32)×0.02±1.8°F)

- Overload protection: 1000 V DC/1000 V AC or 10⁶ V • Hz (energized for 1 minute)
Current under overload: Steady state 15 mA or less, transient state 0.8 A or less

- The DT4910 Thermocouples (K) are used.
- The accuracy does not include the error of the DT4910 Thermocouples (K).
- Display update rate: 3 time/s

*1: In an environment where the temperature of the instrument is ±1°C and stable, the accuracy is specified.

Standard contact temperature compensation stability time: 120 minutes
(When the instrument environmental temperature changes quickly from 50°C to 23°C (122°F to 73°F))

T = reading value (°F)

6

Maintenance and Service

6.1 Repair, Inspection, and Cleaning

DANGER



Customers are not allowed to modify, disassemble, or repair the instrument.

Doing so may cause fire, electric shock, or injury.

Calibrations

IMPORTANT

Periodic calibration is necessary in order to ensure that the instrument provides correct measurement results of the specified accuracy.

The calibration frequency varies depending on the status of the instrument or installation environment. We recommend that the calibration frequency is determined in accordance with the status of the instrument or installation environment and that you request that calibration be performed periodically.

Cleaning

- To clean the instrument, wipe it gently with a soft cloth moistened with water or mild detergent.
- Wipe the display gently with a soft, dry cloth.

IMPORTANT

Never use solvents such as benzene, alcohol, acetone, ether, ketones, thinners or gasoline, as they can deform and discolor the case.

Disposal

Handle and dispose of the instrument in accordance with local regulations.

6.2 Troubleshooting

- When a malfunction of the instrument is suspected, check the information in “Before sending the instrument for repair” and then, if necessary, contact your authorized Hioki distributor or reseller.
- When sending the instrument for repair, remove the batteries and pack it carefully to prevent damage during transportation. Include cushioning material so the instrument cannot move within the package. Be sure to include details of the problem. Hioki cannot be responsible for damage that occurs during transportation.

Before sending the instrument for repair

Symptom	Check and/or remedy
Nothing appears in the display. Or the display disappears after a short time.	Check that the batteries are not exhausted. Replace with new batteries. (p. 24)
	Check that the auto power save function has not been activated. Check the setting of the auto power save function. (p. 49)

Symptom	Check and/or remedy
<p>The measurement value does not appear. Even after the measurement, 0 (zero) still appears. Even after short circuit of the probe, the measured value does not appear. Zero adjustment is not possible.</p>	<p>If the measured current value does not appear, check that the fuse is not blown. Check method: "Check that the fuse is not broken." (p. 32)</p> <p>If the fuse is blown, replace it with the specified fuse. (p. 67)</p>
	<p>If the measured current value does not appear, check that the fuse holder is not deformed. When removing the fuse, the holder is deformed if excessive force is applied. Pinch it with needle-nose pliers and restore the shape of the fuse holder.</p>
	<p>Check that the test lead is not broken. Perform the continuity check to confirm the continuity of the test leads. (p. 30) If the test lead is broken, replace the lead.</p>
	<ul style="list-style-type: none"> • Check that the test leads have been inserted at the ends. • Check that the measurement method is correct. <p>If no problems have been found, the instrument may be malfunctioning. Send the instrument for repair.</p>
	<p>• Check that the test leads have been inserted at the ends.</p> <p>• Check that the measurement method is correct.</p> <p>If no problems have been found, the instrument may be malfunctioning. Send the instrument for repair.</p>
<p>The display does not stabilize and the value fluctuates; it is difficult to read the value.</p>	<p>Check that the input signal is within the input range for the instrument.</p>

Other inquiries

Question	Solution
<p>Would like to perform zero adjustment.</p>	<p>Using the relative value display function, zero adjustment can be performed. (p. 48)</p>

Question	Solution
<p>Would like to replace the fuse.</p> <p>Would like to know how to obtain the fuse.</p>	<p>The fuse can be purchased via authorized Hioki distributor or reseller.</p>
<p>Can rechargeable batteries be used?</p>	<p>Rechargeable batteries can be used. However, the discharge characteristic of these batteries is different from that of alkaline batteries. Be aware that the remaining battery power display does not function properly.</p>

6.3 Replacing Fuses

If a fuse is blown, replace it with a new one as follows.

For details on how to check that the fuse is blown, see “3 Check that the fuse is not broken.” (p. 32).

WARNING



- To avoid electric shock, disconnect the test leads from the object to be measured before replacing the fuse.
- Replace the fuse only with one of the specified type, characteristics, rated current, and rated voltage. Do not use fuses other than those specified (especially, do not use a fuse with higher-rated current) or do not short circuit and use the fuse holder. Doing so may damage the instrument and result in personal injury.

Specified fuses

	Rating	Specifications
For μ A/mA terminal	630 mA/ 1000 V	Manufacturer: SIBA Meltdown characteristics: Fast-blow type Breaking capacity: 50 kA Size: ϕ 6.3 mm \times 32 mm
For A terminal	10 A/ 1000 V	Manufacturer: SIBA Meltdown characteristics: Fast-blow type Breaking capacity: 30 kA Size: ϕ 10 mm \times 38 mm

The fuses can be purchased via authorized Hioki distributor or reseller.

When removing the fuse, do not apply excessive force on the fuse holder. If the fuse holder is deformed, the connection becomes poor and the instrument cannot measure the current.

CAUTION



When replacing the fuse, do not allow foreign matter to enter the instrument. It may cause a malfunction. Do not remove the fuse using the tip of test lead L9206 supplied with the instrument. The tip of the test lead may bend.

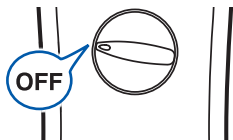

- 1 Remove the test leads from the instrument.
- 2 Set the rotary switch to OFF.

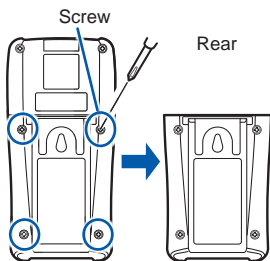

- 3 Remove the holster.
- 4 Using a Phillips screwdriver, remove the screws (4 locations) from the battery cover.
- 5 Remove the battery cover.

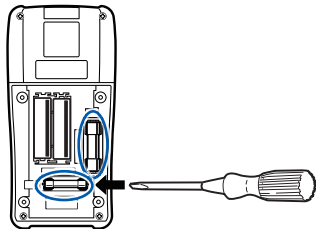

- 6 Replace the fuse.
- 7 Reattach the battery cover.
- 8 Secure the cover with the screw.
- 9 Reattach the holster.

Appendix

Appx. 1 RMS and Average

Difference between the RMS and Average

When converting AC to RMS, 2 methods are available, “True RMS method (True RMS indication)” and “Average method (Average rectifying RMS indication)”.

In the case of the sine wave where no skew is included, the same values are indicated in both methods. However, if the waveform is skewed, a difference occurs between the 2 methods.

The DT4211 (Average value measurement model) uses the Average method, and the DT4212 (True RMS measurement model) uses the True RMS method.

In the true RMS method, the high frequency component is also included and displayed.

In the average method, the input waveform is handled as a sine wave where no skew is included (only single frequency). The average of the AC signal is obtained, converted to the RMS, and then displayed. If the waveform is skewed, a greater measurement error occurs.

RMS and Average

Measurement example	True RMS	Average rectifying
100 V sine wave	100 V	100 V
100 V square wave	100 V	111 V

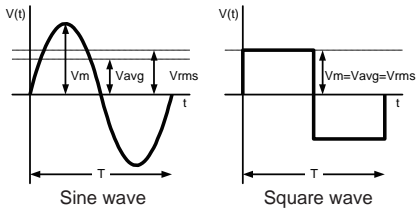

V_m : Maximum value, V_{avg} : Average value, V_{rms} : RMS, T : Time period

Warranty Certificate

Model	Serial No.	Warranty period Three (3) years from date of purchase (___ / ___)
<p>This product passed a rigorous inspection process at Hioki before being shipped.</p> <p>In the unlikely event that you experience an issue during use, please contact the distributor from which you purchased the product, which will be repaired free of charge subject to the provisions of this Warranty Certificate. This warranty is valid for a period of three (3) years from the date of purchase. If the date of purchase is unknown, the warranty is considered valid for a period of three (3) years from the product's date of manufacture. Please present this Warranty Certificate when contacting the distributor. Accuracy is guaranteed for the duration of the separately indicated guaranteed accuracy period.</p> <ol style="list-style-type: none">1. Malfunctions occurring during the warranty period under conditions of normal use in conformity with the Instruction Manual, product labeling (including stamped markings), and other precautionary information will be repaired free of charge, up to the original purchase price. Hioki reserves the right to decline to offer repair, calibration, and other services for reasons that include, but are not limited to, passage of time since the product's manufacture, discontinuation of production of parts, or unforeseen circumstances.2. Malfunctions that are determined by Hioki to have occurred under one or more of the following conditions are considered to be outside the scope of warranty coverage, even if the event in question occurs during the warranty period:<ol style="list-style-type: none">a. Damage to objects under measurement or other secondary or tertiary damage caused by use of the product or its measurement resultsb. Malfunctions caused by improper handling or use of the product in a manner that does not conform with the provisions of the Instruction Manualc. Malfunctions or damage caused by repair, adjustment, or modification of the product by a company, organization, or individual not approved by Hiokid. Consumption of product parts, including as described in the Instruction Manuale. Malfunctions or damage caused by transport, dropping, or other handling of the product after purchasef. Changes in the product's appearance (scratches on its enclosure, etc.)g. Malfunctions or damage caused by fire, wind or flood damage, earthquakes, lightning, power supply anomalies (including voltage, frequency, etc.), war or civil disturbances, radioactive contamination, or other acts of Godh. Damage caused by connecting the product to a networki. Failure to present this Warranty Certificatej. Failure to notify Hioki in advance if used in special embedded applications (space equipment, aviation equipment, nuclear power equipment, life-critical medical equipment or vehicle control equipment, etc.)k. Other malfunctions for which Hioki is not deemed to be responsible <p>*Requests</p> <ul style="list-style-type: none">• Hioki is not able to reissue this Warranty Certificate, so please store it carefully.• Please fill in the model, serial number, and date of purchase on this form. <p style="text-align: right;">13-09</p>		
HIOKI E.E. CORPORATION 81 Koizumi, Ueda, Nagano 386-1192, Japan TEL: +81-268-28-0555 FAX: +81-268-28-0559		

HIOKI

DT4211

DT4212

数字万用表

使用说明书

2013年11月 修订一版 DT4211A981-01 13-11H

Chinese

附录

前言	1
核对包装内容	1
选件（另售）	2
安全注意事项	4
使用注意事项	8

1 概述 13

1.1 概述和特性	13
1.2 各部分的名称和功能	14
1.3 显示	19

2 测量准备 21

2.1 测量流程	21
2.2 安装/更换电池	22
2.3 使用测试线	24

3 执行测量 27

3.1 使用前的检查	27
3.2 测量电压	31
测量交流电压	31
测量直流电压	32
3.3 测量电阻	33
3.4 测量二极管	34
3.5 导通检查	35
3.6 测量静电容量	36
3.7 测量频率	37
3.8 测量占空比	38
3.9 测量电流	39
测量直流/交流电流	39

3.10 测量温度 (DT4212)	41
4 便利的使用方法	43
4.1 选择测量量程	43
用自动量程测量	43
用手动量程测量	43
4.2 保持测量值.....	44
保持测量值 (HOLD)	44
4.3 确认相对值/执行调零.....	45
确认相对值 (REL)	45
执行调零.....	46
4.4 打开背光灯.....	47
4.5 使用自动节电 (APS)	47
5 规格	49
5.1 一般规格	49
5.2 电气特性	51
5.3 精度表	53
6 维护和检修	61
6.1 维修、检查和清洁.....	61
6.2 故障诊断	62
6.3 更换熔断器.....	64
附录	附录1
附录1 有效值与平均值	附录1

前言

感谢您购买 HIOKI DT4211 (平均值测量型)、DT4212 (真有效值测量型) 数字万用表。

要获得产品的最大性能, 请首先阅读本手册, 并保管在身边以备将来查阅。

核对包装内容

当您收到本仪表时, 请仔细检查, 确保装运期间没有发生损伤。尤其要检查附件、面板开关和连接器。如果损伤明显, 或者不能按照规格动作, 请联系代理店或距您最近的营业所。

按照如下要求检查包装内容。

- DT4211 (平均值测量型) 或 DT4212 (真有效值测量型)

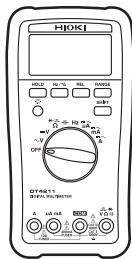

DT4211
(平均值测量型)

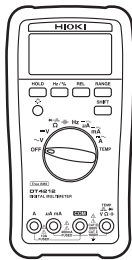

DT4212
(真有效值测量型)

- L9206 测试线
(p. 25)



- 5号锰电池 (R6P) × 2



- 使用说明书



皮套已安装。

选件 (另售)

选件 (另售)

本仪表有以下一些选件可用, 订货时, 请联系代理店或距您最近的营业所。

连接电缆

*1: CAT IV 600 V/CAT III 1000 V/CAT II 1000 V

*2: CAT IV 600 V/CAT III 1000 V

*3: CAT III 1000 V *5: CAT III 300 V/CAT II 600 V

*4: CAT III 600 V *6: AC33 V /DC70 V

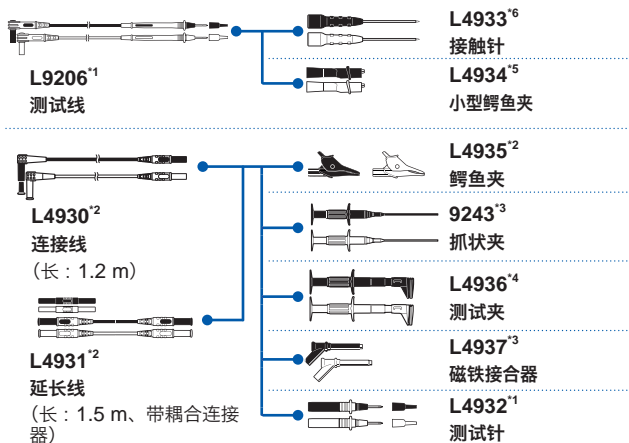

温度测量 (仅限 DT4212 (真有效值测量型))



DT4910 K 型热电偶 (p. 41)

- 测温连接点：开槽式 (焊接)
- 传感器长度：约 800 mm
- 使用温度：-40°C 至 260°C (测温部位)、-15°C 至 55°C (连接器)
- 容差：±2.5°C

携带盒



C0201 携带盒

可将本仪表、测试线、使用说明书和其他东西装进盒里。



C0202 携带盒

可将本仪表、测试线、使用说明书和其他东西装进盒里。

Z5004 带磁铁吊带



将吊带系在本仪表上，并确保使用中吊带被牢牢固定在像金属板那样的壁面上。

吊带的处理 (p. 10)

有关 C0201 携带盒及 Z5004 带磁铁吊带的详细使用方法，请参考本公司网页。

安全注意事项

本仪表遵照 IEC61010 安全标准设计，且在装运前经过全面安全测试。但是，用本手册没有记录的方法使用本仪器可能使提供的安全特性失效。

使用本仪表前，务必仔细阅读以下安全注意事项。

危险



错误使用可能导致人身伤害或死亡，并损坏本仪表。使用前，请您务必理解本手册中的使用说明和步骤。

警告



关于电源供应，电路短路有引发触电、发热、火灾和电弧放电的风险。如果不熟悉电气测量仪表的人要使用本仪表，必须由熟悉此类仪表的人指导操作。

保护用具







警告











测量火线时为避免触电，应穿戴绝缘橡胶手套、安全鞋和安全头盔等合适的保护用具。

记号



本手册将风险程度和危险级别分类如下。

 危险	表示可能导致操作者死亡或重伤的紧迫危险状态。
 警告	表示可能导致操作者死亡或重伤的潜在危险状态。
 注意	表示可能导致操作者轻微或中度伤害或者导致本仪表损坏或故障的潜在危险状态。
重要	表示与本仪表操作或维护任务有关的信息，操作者必须非常熟悉这些信息和内容。
	表示高压危险。 如果不进行详细的安全检查或者本仪表被误用，可能引发危险状态，操作者可能遭受电击，可能被烫伤或者甚至可能遭受致命的人身伤害。
	表示强磁场危险。 磁力的影响可能引起心脏起搏器或医用电子设备工作不正常。
	表示禁止行为。
	表示必须被执行的行为。
*	更进一步的信息阐述如下。

本仪表上的符号

	表示注意和危险。当本仪表上显示有该符号时，查阅本操作手册的相关主题。
	表示该端子可能出现危险电压。
	表示双重绝缘或强化绝缘所保护的设备。
	表示熔断器。
	表示接地端子。
	表示直流 (DC)。
	表示交流 (AC)。
	表示直流 (DC) 或交流 (AC)。

各种标准的符号

	表示欧盟成员国关于废弃电子电气设备的指令 (WEEE 指令)。
	表示本仪表遵守 EC 指令规定的规则。

精度

我们用术语 **rdg.** (读取) 和 **dgt.** (数字) 值定义测量误差，其含义如下：

rdg.	(读取或显示数值) 表示现在正在测量的值、测量仪表上正显示的值
dgt.	(分辨率) 数字测量仪表可显示的最小单位，即表示最小位的“1”。

测量分类

为确保测量仪表的安全操作，IEC61010 为被分类为 CAT II 至 CAT IV 的各种电气环境建立安全标准，称其为测量分类。

⚠ 危险



- 在指定使用较大编号分类的环境使用核准分类低于此的测量仪表，可能导致严重的意外事故，此类行为必须被严格避免。
- 在一个没有被指定为 CAT II 至 CAT IV 分类的环境使用测量仪表，可能导致严重的意外事故，此类行为必须被严格避免。

本仪表符合 CAT II 1000V、CAT III 600V 的安全要求。

CAT II: 当直接测量装置上的初级侧电路的插座，而该装置被电源线连接到交流电插座上时（移动工具、家用电器等）

CAT III: 当直接测量被直接连接到配电盘上的重型装置（固定装置）的初级侧电路，并从配电盘到插座连接支线路时

CAT IV: 当测量使用入口至检修入口以及至电表和初级侧过电流保护设备的电路（配电盘）时

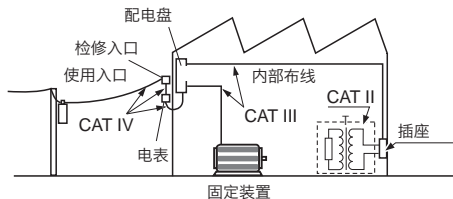

参见：“2.3 使用测试线”（p. 24）

使用注意事项

以下这些预防措施确保安全操作，并获得各种功能的全部益处。

危险

如果测试线或者本仪表损坏，存在触电的风险。使用本仪表前，执行以下检查。



- 使用本仪表前，检查测试线的被覆层既没有裂开也没有剥落，并且没有金属部分暴露。在有损坏的状况下使用本仪表可能会发生触电事故。请用我们公司指定的产品更换测试线。
- 为避免触电，请检查并确保电缆内的白色或红色的部分（绝缘层）未外露。若电缆内的彩色部分露出，请勿使用。
- 首次使用本仪表前，进行检查并确认其工作正常，以确认保存或装运期间没有损伤。如果您发现任何损坏，请联系代理店或距您最近的营业所。

关于本仪表的安装

将本仪表安装在不合适的地方可能引起故障，或者可能引起意外事故。请避免安装在以下场所。

有关使用温度和湿度的详情，参见规格。（p. 49）

注意



- 直接暴露在阳光或高温下
- 暴露在腐蚀性气体或易燃气体中
- 暴露在水、油、化学物质或溶剂中
- 暴露在高湿或结露的环境中
- 暴露在强电磁场或者静电环境中
- 暴露在有大量尘埃微粒的环境中
- 靠近感应加热系统（例如高频感应加热系统和 IH 烹饪装置）
- 机械振动大的地方
- 不稳定的平台或者斜面

用支架立起本仪表

⚠ 注意



- 不要将本仪表固定在不稳定的平台或者斜面上。
- 当本仪表用支架立起时，不要在其上施加过大的力。这样做可能损坏支架。



电缆的处理

⚠ 警告

为防止触电，当测量电源线路的电压时，使用满足以下标准的测试线：



- 符合安全标准 IEC61010 或 EN61010
- 测量分类为 II 或 III
- 其额定电压大于要测量的电压

为本仪表准备的所有可选测试线均符合安全标准 EN61010。根据指定的测量分类和额定电压，使用合适的测试线。

⚠ 注意



- 避免踩踏或者挤压电缆，否则可能损伤电缆绝缘。
- 为避免损伤电缆，不要弯曲或拉扯引线和探头基座。



测试线前端尖锐，请小心使用以避免人身伤害。

有关本仪表附带的或者作为选件的测试线，参见以下信息。

附件和选件	参考章节
测试线	“2.3 使用测试线” (p. 24)
K 型热电偶	“3.10 测量温度 (DT4212)” (p. 41)

吊带的处理

危险



身上有起搏器等医用电子设备的人请勿使用 Z5004 带磁铁吊带，也请不要靠近 Z5004。此举极其危险，电子设备可能工作不正常，并且操作者的生命可能被置于极大的风险中。

注意



- 在可能暴露于雨水、灰尘或者可能结露的地方，不要使用 Z5004。在这些环境中，Z5004 可能会腐蚀劣化。并且，磁铁的磁性可能被削弱，本仪表可能会掉落。
- 不要让 Z5004 靠近软盘、磁卡、充值卡或者磁性票据等磁性媒介。这样做可能使这些东西出错或者不能使用。此外，如果让 Z5004 靠近计算机、电视屏幕或者电子手表等精密电子装置，可能会发生故障。

测量期间的注意事项

警告



如果在超过本仪表或探头额定参数的地方使用本仪表，本仪表可能损坏，并导致人身伤害。请不要在那样的地方使用本仪表。

参见“测量分类” (p. 7)。

- 关于 10 A 量程，最大输入电流是 DC10 A/AC10 Arms。超过此电流可能损坏本仪表，并导致人身伤害。请不要输入超过指定上限的电流。



为避免触电或短路事故，请注意以下事项。

- 空闲输入端子可能发生危险电压。请不要触摸空闲端子。
- 只使用我们公司指定的测试线和选件。
- 不要用测试线的金属部分接触测量电路的 2 线之间。绝对不要触摸金属部分。
- 当把夹型测试线连接到通电端子上时，请不要接触到 2 线之间。

注意



- 请不要输入超过指定量程的电压或者电流。这样做可能损坏本仪表。
- 在导通检查、二极管测试、电阻测量或者静电容量测量期间，测量信号发生在本仪表的端子上。根据测量目的，测量信号可能引起损坏。

参见精度表 (p. 53) 中的“测量电流”和“开路电压”，事先检查有无测量电流和开路电压的不利影响。

装运期间的预防措施

装运期间请注意以下事项。Hioki 不对装运期间发生的损坏负责。

注意



- 装运本仪表期间，小心操作，避免因振动或冲击被损坏。
- 为避免损坏，装运前从本仪表上拆下附件和选件。

如果本仪表长期不被使用

重要

如果本仪表将被长期保存，为避免电池漏液腐蚀或损坏本仪表，请从本仪表上取出电池。

1

概述

1.1 概述和特性

本仪表为多功能数字万用表，可测量电压、电流、电阻和电容等项目。

主要特性和功能

- 大显示屏，易于读取测量值
- 环境性能（可在任何地方使用）（操作温度：-10°C 至 50°C）
- 显示保持 (HOLD)
- 低功耗，可使用较长时间

您有找不到合适安装地点的困扰吗？

带磁铁的吊带，可方便地悬挂设备。

大数值显示屏

带有背光灯，用户在昏暗环境中也可读取测量值

根据用途

测量用的测试线和前端探针可选。

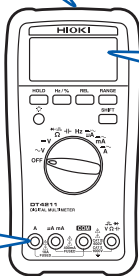
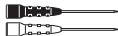

RANGE:AUTO HOLD
~ 1000 V

1.2 各部分的名称和功能

正面

DT4211 (平均值测量型) 和 DT4212 (真有效值测量型) 的一些标识不同

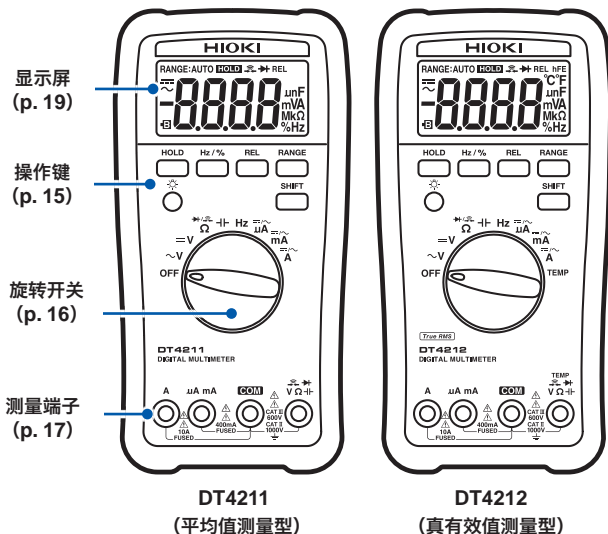

操作键

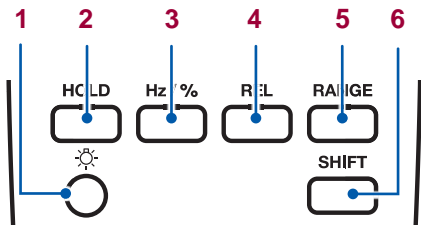

- | | | |
|---|---|--|
| 1 |  | 背光键
打开 / 关闭背光灯。(p. 47) |
| 2 | HOLD | 手动设置 / 取消保持数值显示功能。(HOLD 点亮 / 熄灭。)
(p. 44) |
| 3 | Hz/% | 切换频率 (p. 37) 和 占空比 (p. 38) 显示。 |
| 4 | REL | 显示相对值 (REL)。(p. 45) ([REL] 点亮 / 熄灭。) |
| 5 | RANGE | 设置手动量程和切换量程。(p. 43)
(打开 / 关闭 [RANGE:AUTO])
取消手动量程。(按 1 秒以上。) |
| 6 | SHIFT | 切换功能。
取消自动节电功能 (APS)。(电源接通选项) |

旋转开关和测量描述

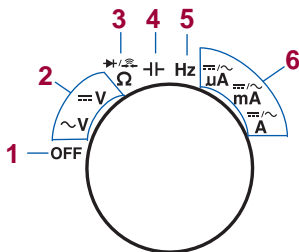

DT4211
(平均值测量型)

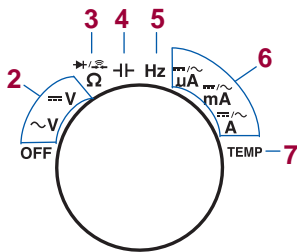

DT4212
(真有效值测量型)

测量功能		DT4211	DT4212
1	OFF		
2	$\sim V$ 交流电压和频率测量	✓	✓
	$\equiv V$ 直流电压测量	✓	✓
3	Ω 电阻测量	✓	✓
	$\rightarrow $ 二极管测试	✓	✓
	$\rightarrow $ 导通检查	✓	✓
4	$- -$ 静电容量	✓	✓
5	Hz 频率和占空比测量	✓	✓
6	$\equiv/\sim \mu A$ 直流电流 (μA) 测量 / 交流电流 (μA) 测量	✓	✓
	$\equiv/\sim mA$ 直流电流 (mA) 测量 / 交流电流 (mA) 测量	✓	✓
	$\equiv/\sim A$ 直流电流 (A) 测量 / 交流电流 (A) 测量	✓	✓
7	TEMP 温度测量	-	✓

测量端子

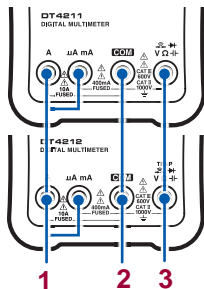

DT4211
(平均值测量型)

DT4212
(真有效值测量型)

- 1 电流测量端子。
以下均表示为“A端子(μA端子、mA端子)”。
连接红色测试线。
- 2 各种测量通用的端子。
以下均表示为“COM端子”。
连接黑色测试线。
- 3 用于电压测量、电阻测量、导通检查、二极管测试、温度测量或静电容量测量。
以下均表示为“V端子”。
连接红色测试线。

务必仔细阅读以下关于带有 \triangle 标记的端子的注意事项。

- “装运期间的预防措施”(p. 12)
- “6.3 更换熔断器”(p. 64)

背面

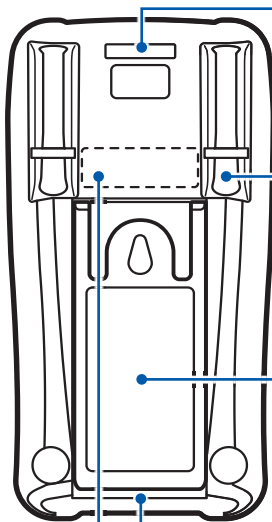

吊带固定孔

可安装选件 Z5004 带磁铁吊带。

测试线支座

可固定测试线。

支架

用支架立起。



序列号标签

这是管理所必需的产品保证。
不要撕掉标签。
检查序列号之前，先拆下皮套。

电池盖板

当更换电池 (p. 22) 或熔断器 (p. 64) 时，拆下盖板。

⚠ 参见 p. 22。

1.3 显示

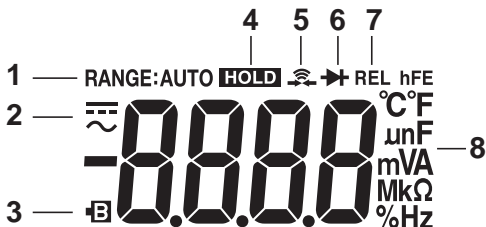

1	RANGE: AUTO	自动量程 (p. 43)
2		直流、交流
3		电池警告指示器 当电池电压低于可保证测量精度的电压时点亮 (2.4 V ± 0.15 V)。
4	HOLD	测量值保持。(p. 44)
5		导通检查 (p. 35)
6		二极管 (p. 34)
7	REL	相对值显示 (p. 45)
8	各测量单位	

显示

2

测量准备

2.1 测量流程

使用本仪表前，务必阅读“使用注意事项”（p. 8）。

安装和连接

安装电池。（p. 22）

可根据需要准备其他选项。

执行启动检查。（p. 27）

测量

打开电源，并选择测量功能。

将测试线接在测量端子上。（p. 24）
（根据需要执行调零操作。（p. 46））

将测试线连接到被测物上。

（若有必要）

保持测量值的显示。（p. 44）

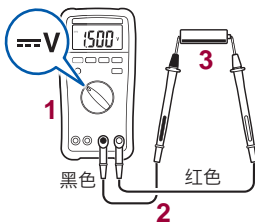

为确保安全操作，务必先选择测量功能，然后将测试线连接至被测物。

测量结束

将测试线从被测物上移开，并关闭电源。

2.2 安装 / 更换电池

首次使用本仪表前，安装 2 节 5 号锰电池 (R6P) 或碱性电池 (LR6)。测量前请确认检查电池电量充足。当电池电量低时，更换电池。

警告



为避免触电，更换电池前，请先拆下测试线。



为避免爆炸，不要对电池进行短路、充电、分解或者火烧。



更换电池后，请重新装上并拧紧电池盖板后再使用本仪表。

注意

请遵守以下事项，否则可能会造成性能劣化或电池漏液。



- 不要混用新旧电池或者不同型号的电池。
- 安装时请注意电池的正负极，不要装反。
- 不要使用质保已过的电池。
- 不要将用完的电池留在本仪表内。



- 如果本仪表将被长期保存，为避免电池漏液引起腐蚀或损坏本仪表，从本仪表上取出电池。

- **B** 电池电量耗尽时点亮。无法保证精度。请立即更换电池。
- 使用后，务必关闭本仪表。
- 依据当地规定使用和处理电池。

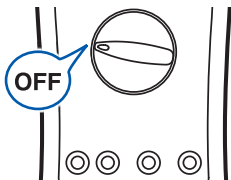

1 请准备以下物品。

- 十字螺丝刀
- 5号锰电池 (R6P) × 2 或
5号碱性电池 (LR6) × 2

2 从本仪表上拆下测试线。

3 将旋转开关切换到 OFF。

4 卸下皮套。

5 使用十字螺丝刀，从本仪表背面的电池盖板上拆下螺钉 (4 处)。

6 拆下电池盖板。

7 取出所有旧电池。

8 安装 2 节新的 5 号锰电池 (R6P)，注意电池极性。

9 重新装上电池盖板。

10 用螺钉紧固盖板。

11 装回皮套。

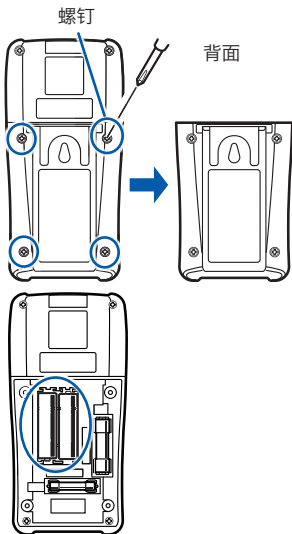

电池盖板被拆下后，可看见熔断器。更换熔断器时，参见“6.3 更换熔断器” (p. 64)。

2.3 使用测试线

为本仪表提供的测试线 L9206 用于测量。

请根据测量地点，使用我们的选件测量电缆。有关选件的详情，参见“选件（另售）”（p. 2）。

危险



为避免触电，当施加电压时请勿从测试线前端短接线路。

警告



- 当按照 CAT III 测量分类进行测量时，为防止短路事故，务必使用安装了套管的测试线。（参见“测量分类”（p. 7））
- 测量期间，如果套管不小心掉落，请停止测量。
- 连接测试线时，使用正确的电压测量端子（V 端子）和电流测量端子（A 端子）。如果使用未正确连接的测试线，本仪表可能会受损或可能发生短路事故。
- 只使用我们公司指定的测试线和选件。

注意



- 要确保安全操作，请只使用我们公司指定的测试线。
- 当用套管进行测量时，避免损坏套管。
- 金属探针的前端锋利，可能导致人身伤害。请不要触摸前端。

L9206 测试线

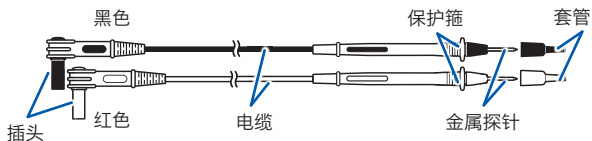

金属探针 连接到要测量的物体上
4 mm 以下 (装有套管)
19 mm 以下 (未装套管)
直径 ϕ 大约 2 mm

套管 套在金属探针上以防短路事故。

保护箍 表示相距金属探针的安全操作距离。

测量期间，不要触摸保护箍与套管前端的区域。

插头 连接到本仪表的测量端子上。

电缆 双重绝缘线 (长：约 980 mm，直径： ϕ 约 3.5 mm)

当电缆内部的白色部分露出时，请更换新的 L9206 测试线。

拆下和套上套管

拆下套管

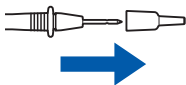

轻握套管底部，并拉出套管。
妥善存放拆下的套管以免弄丢。

套上套管

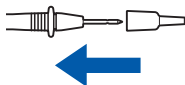

将测试线的金属探针插进套管的孔内，将它们牢固地插到底。

连接到本仪表上

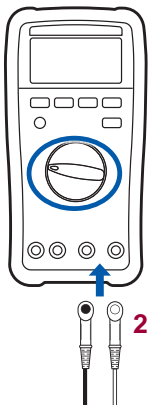

- 1 将旋转开关拧到希望测量的功能。
- 2 将测试线连接到相应的测量端子上。

- 电流测量除外

COM 端子

连接黑色测试线。

V 端子

连接红色测试线。

- 电流测量

COM 端子

连接黑色测试线。

$\mu\text{A}/\text{mA}$ 端子

连接红色测试线。

A 端子

3

执行测量

3.1 使用前的检查

首次使用本仪表前，为确保没有因保存或运输造成损坏，请进行检查并确认其工作正常。如果您发现任何损坏，请联系代理店或距您最近的营业所。

本仪表与测试线的外观检查

检查项目	处理
本仪表既无损坏又无破裂。 内部电路没有露出。	对本仪表进行外观检查。 如果已损坏，存在触电风险。请勿使用本仪表，并将其送去维修。
端子未附着金属片等垃圾。	用棉签清除污渍。
测试线的被覆层无破损，内部的白色部分或金属部分未露出。	如果测试线已损坏，存在触电风险。请勿使用本仪表，并将其送去维修。

接通电源时的检查

(将旋转开关置于 OFF 以外的档位。)

检查项目	处理
电池电量足够。	当  出现在显示屏 左下部，表明电池电压低。无法保证精度。请立即更换电池。

操作检查

本节介绍一些操作检查项目。为确保本仪表按照参数正常动作，需要定期校正。

1 检查测试线是否有破损。

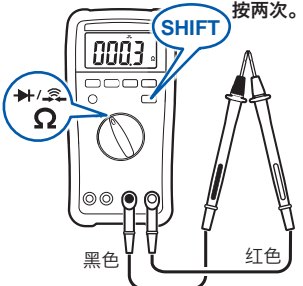
检查方法	处理
<p>利用导通检查，短接测试线并确认显示。</p>  <p>按两次。</p> <p>黑色 红色</p>	<p>正常： 蜂鸣器鸣响，数值稳定于 0Ω 左右。</p> <p>不正常： 蜂鸣器不鸣响，出现的数值超出上述范围。</p> <p>处理方法： 测试线可能已断线。用我们公司指定的产品更换测试线。 如果更换测试线后依然存在同样的现象，本仪表可能发生了故障。停止检查，并送本仪表修。</p>

2 测量数值已知的样品 (例如电池、工频电源、电阻等), 确认是否为规定的值。

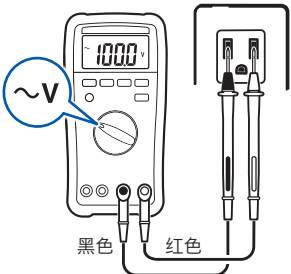
检查方法	处理
<p>例子： 执行交流电压测量，测量工频电源并确认显示。</p> 	<p>正常： 显示规定的值。 (在本例中，应该出现工频电压值。)</p> <p>不正常： 测量值不出现。 本仪表可能发生了故障。 停止检查，不使用本仪表。</p>

3 确认熔断器是否熔断。

检查方法	处理							
1. 从本仪表上拆下熔断器。(p. 64) 2. 重新装上电池盖板。 3. 利用电阻测量确认熔断器的电阻。 (电阻测量 (p. 33))	正常： <table border="1" data-bbox="519 282 923 428"> <thead> <tr> <th data-bbox="519 282 724 326">熔断器额定电流</th> <th data-bbox="724 282 923 326">电阻</th> </tr> </thead> <tbody> <tr> <td data-bbox="519 326 724 377">630 mA</td> <td data-bbox="724 326 923 377">约 1.0Ω</td> </tr> <tr> <td data-bbox="519 377 724 428">10 A</td> <td data-bbox="724 377 923 428">约 0.1Ω</td> </tr> </tbody> </table> 不正常： 如果没有获得上述值(显示更大的值)，更换熔断器。(p. 64)		熔断器额定电流	电阻	630 mA	约 1.0Ω	10 A	约 0.1Ω
熔断器额定电流	电阻							
630 mA	约 1.0Ω							
10 A	约 0.1Ω							

测量前

警告

请遵守以下项目，以免发生短路事故。



- 连接测试线前，务必确认旋转开关的设置。
- 切换旋转开关前，从被测物上取下测试线。
- 本仪表的操作及连接，请按照各个测量例的顺序(或顺序编号)来进行。

3.2 测量电压

可测量交流 / 直流电压。此外，还可查看交流频率和占空比。

测量前

警告



如果在超过本仪表或探头额定参数的地方使用本仪表，本仪表可能损坏，并导致人身伤害。请不要在那样的地方使用本仪表。

参见“测量分类” (p. 7)。

本仪表的自动量程调节功能会自动选择最佳的测量量程。要任意改变量程，请使用手动量程。(p. 43)

测量交流电压

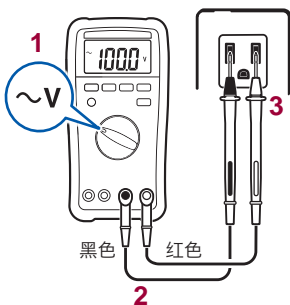

测量交流电压。

测量值为平均值整流成有效值指示 (DT4211) 或真有效值指示 (DT4212)。(p. 附录 1)

按下 **Hz/%** 键时，便可测量频率和占空比。(p. 38)

测量直流电压

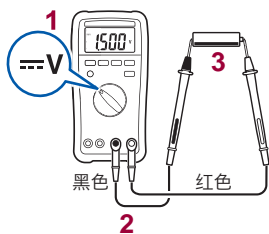

测量直流电压。

3.3 测量电阻

测量电阻。

警告



测量前，务必关闭测量电路的电源。否则可能发生触电事故或者本仪表被损坏。

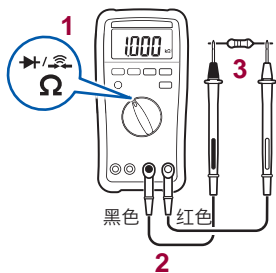

开路端子电压大约 0.5 V 以下。测量电流 (DC) 因量程而异。为避免损坏被测物，使用前请先确认相关参数。

3.4 测量二极管

测量二极管的正向电压。

如果正向电压处于 0 V 至 1 V 的范围，则显示正向电压。

警告



测量前，务必关闭测量电路的电源。否则可能发生触电事故或者本仪表被损坏。

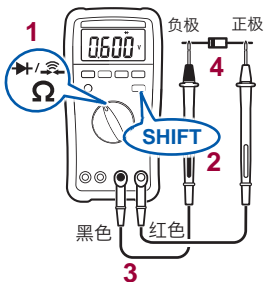

反接的情况



开路端子电压大约 3.0 V 以下。

为避免损坏被测物，使用前请先确认被测物的规格。

3.5 导通检查

检测输入的短路，并通过蜂鸣器通知。

警告



测量前，务必关闭测量电路的电源。否则可能发生触电事故或者本仪表被损坏。

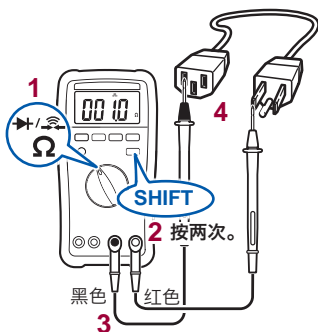

蜂鸣器持续鸣响（检测到短路），显示电阻。
(400Ω 固定量程)

检测	阈值	蜂鸣器
短路检测	90Ω ± 40Ω 或更小	声音 (连续的蜂鸣器鸣响)

3.6 测量静电容量

测量电容器的容量。

警告



测量前，务必关闭测量电路的电源。否则可能发生触电事故或者本仪表被损坏。



不要测量已充电的电容器。

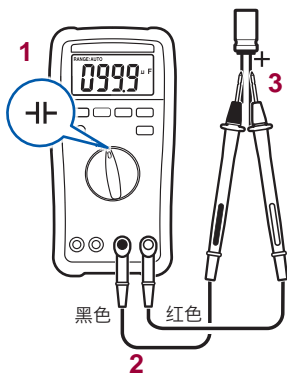

• 当测量极性电容器时

将 V 端子 (红色测试线) 连接到电容器的 + 极端子，并将 COM 端子 (黑色测试线) 连接到 - 极端子。

- 测量电路板上的元器件时，可能会因周边电路的影响而无法测量。

3.7 测量频率

同时也测量被测信号(方波)的频率。频率显示可自动调节量程。

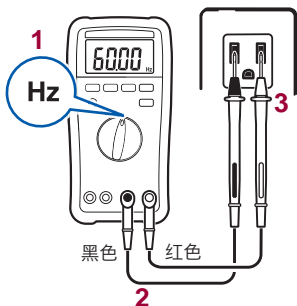

测量交流电压和交流电流的频率

测量交流电压时，应使用 ACV 设置；测量交流电流时，应使用 AC μ A、ACmA 或 ACA 设置。按 **Hz/%** 键 ([Hz] 点亮) 后，可查看频率。按下 **Hz/%** 键之前，电压(电流)量程是固定的。

- 如果测到频率测量量程以外的信号，显示将变得不稳定。请注意这一情况。
- 频率测量的灵敏度根据各量程有所规定。(最小灵敏度电压 (p. 56) 当数值小于最小灵敏度电压(电流)时，指示值可能波动。此时缩小电压(电流)量程即可稳定数值。但是这并不适用于噪声引起数值波动的情形。
- 在低频电压(电流)测量过程中，如果因自动量程不稳定而导致无法测量频率，请更换电压(电流)量程再测。

3.8 测量占空比

占空比 (占空因数) 表示脉冲宽度和脉冲重复频率的比值。本仪表以百分比 (%) 的形式显示该比值。

叠加斜坡的占空比 (D+) : $D+ = tw+ / T \times 100 (\%)$

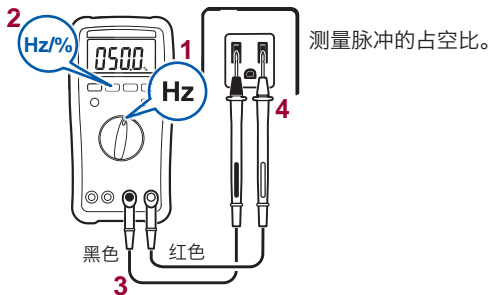
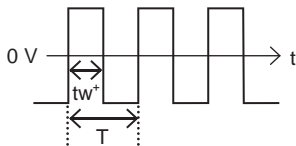

测量交流电压和交流电流的占空比

测量交流电压时, 应使用 ACV 设置; 测量交流电流时, 应使用 AC μ A、ACmA 或 ACA 设置。按下 **Hz/%** 两次, 可查看占空比。按下 **Hz/%** 键之前, 电压 (电流) 量程是固定的。

3.9 测量电流

测量直流 / 交流电流。使用 **SHIFT** 键可在直流和交流间切换。

危险



- 不要向电流测量端子输入任何电压。这样做可能导致短路事故。
- 为避免电气意外事故，测量前关闭电路的电源，然后连接测试线。

测量直流 / 交流电流

测量功能

- **μA** 测量 4000 μA 或更小的直流 / 交流电流时选择。
- **mA** 测量 400.0 mA 或更小的直流 / 交流电流时选择。
- **A** 测量 10 A 或更小的直流 / 交流电流时选择。

当测量未知电流时

设置为大量程。

用 μA 量程测量

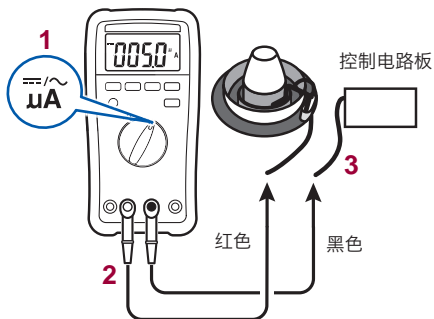

例子：当测量燃烧器框架电流 (μA) 时

燃烧器框架电流测量值随仪表输入阻抗而异。
本仪表的 μA 输入阻抗大约为 100Ω 。

用 A 量程测量

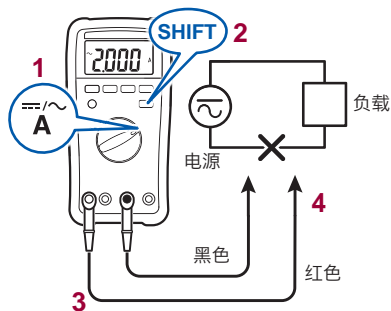

3.10 测量温度 (DT4212)

使用选件 DT4910 K 型热电偶，可测量温度。

⚠ 注意



为避免损坏本仪表，不要向热电偶输入任何电压或者电流。

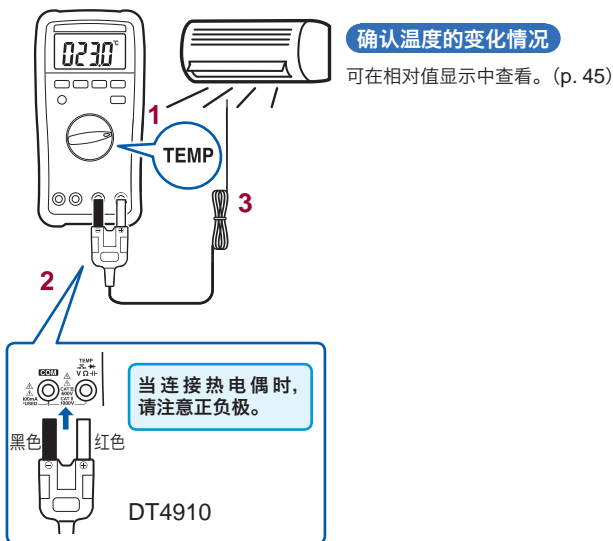

当将热电偶附于被测物的表面测量温度时

清洁表面，以便热电偶能够与物体切实地接触。

若连接热电偶后未测量到温度

本仪表或者热电偶可能发生故障。

按照以下步骤进行检查。

用测试线短接本仪表的 V 端子。

显示周围温度。

热电偶可能正发生故障 (断线)。
更换一个新的热电偶。

未显示周围温度。

本仪表发生故障。送去维修。

4

便利的使用方法

4.1 选择测量量程

可自动选择或手动选择量程。

- 自动量程 根据实际的测量情况自动设置最佳量程。
- 手动量程 手动设置特定量程。

用自动量程测量



[RANGE:AUTO] 点亮。

使用旋转开关切换测量功能时，将启用自动量程。

用手动量程测量



按 **RANGE** 键。

[RANGE:MANUAL] 点亮。

每按一次 **RANGE** 键，就切换为更上一级量程。当该键被按至最大量程时，再按一次将被指定为最小量程。

示例： 量程为 400.0 mV 至 1000 V 时
400.0 mV → 4.000 V → 40.00 V →
400.0 V → 1000 V → 400.0 mV

要从手动量程切换至自动量程，按 **RANGE** 键 1 秒以上。

4.2 保持测量值

当 **HOLD** 被按下，测量值被保持。(HOLD 点亮。)

保持测量值 (HOLD)

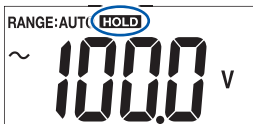

要保持测量值，按 **HOLD** 键。

(HOLD 点亮，测量值被保持。)

要取消保持状态，再按一次。

(HOLD 熄灭。)

4.3 确认相对值 / 执行调零

可确认相对于标准值的相对值（相对功能）。

也可被用于调零功能。

调零以消除测试线的导线电阻（导通、电阻测量）和导线容量（电容测量）的影响。

在以下情况下，该功能被禁用。

在 OL 显示、频率测量和占空比测量时

确认相对值 (REL)

例子：直流电压测量



测得标准数值后，按 **REL** 1 秒以上。

(REL 点亮)

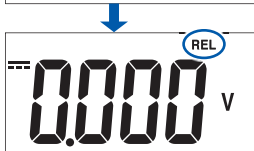

将显示相对值。
要取消显示，再按一次。

(REL 熄灭。)

- 当执行相对功能时，自动量程取消。（但不包括电容测量功能。）
- 对于直流电压、直流电流和温度测量，请勿输入计数 4000 次以上的值（仅 DT4212）。

执行调零

当执行调零时，测试线的状态根据测量功能而异。

参考下表，执行调零。

测量功能	V, Ω , μ , A	+
测试线的状态	短路	开路

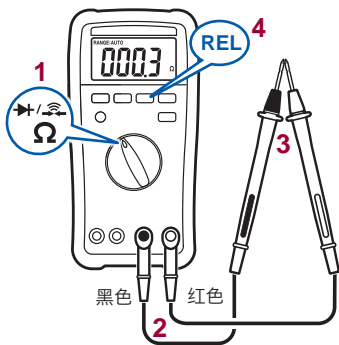

例子 1：电阻测量

- 1 选择测量功能。
 - 2 将测试线接在测量端子上。
 - 3 短接测试线。
 - 4 按 REL 键。
- (调零后：0.0Ω)
- 5 测量电阻。

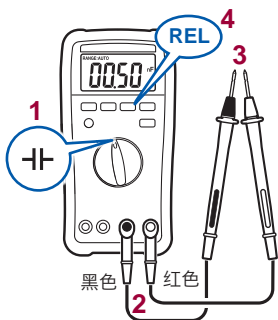

例子 2：电容测量

- 1 选择测量功能。
 - 2 将测试线接在测量端子上。
 - 3 将测试线设为开路。
 - 4 按 REL 键。
- (调零后：0.00 nF)
- 5 测量电容。

4.4 打开背光灯

按下背光键，可打开 / 关闭背光灯。

仪表闲置约 80 秒后，背光灯将自动关闭。

4.5 使用自动节电 (APS)

自动节电功能可减少电池电量消耗。如果仪表闲置约 30 分钟，将进入睡眠模式。

作为默认设置，自动节电功能被设为启用。

要继续使用本仪表，按任意键或者转动旋转开关。

自动节电功能

- 当仪表处于睡眠模式中，按任意键便可从睡眠模式中恢复。
- 如果本仪表将长时间被使用，请将自动节电功能设为无效。
- 使用后，将旋转开关设为 OFF。睡眠模式只消耗少量电流。

取消自动节电功能 (APS)。

按住 **SHIFT** 键，同时转动旋转开关。

5

规格

5.1 一般规格

电源	5 号锰电池 (R6P) × 2 或 5 号碱性电池 (LR6) × 2
电池指示器电压警告	 在 2.4 V ± 0.15 V 或以下时亮起
尺寸	约 91.6 W × 180.6 H × 57.1 D mm (包括皮套)
重量	约 388 g (包括电池和皮套)
使用环境	室内、污染度 2、最高海拔 2000 m
使用温湿度范围	<ul style="list-style-type: none">• 温度 -10°C 至 50°C (但是, 温度功能为 0°C 至 50°C)• 湿度 0°C 至 40°C : 80% RH 以下 (无结露) 40°C 至 45°C : 60% RH 以下 (无结露) 45°C 至 50°C : 50% RH 以下 (无结露)• 湿度 (40MΩ 量程) 0°C 至 30°C : 80% RH 以下 (无结露) 30°C 至 40°C : 70% RH 以下 (无结露) 40°C 至 45°C : 60% RH 以下 (无结露) 45°C 至 50°C : 50% RH 以下 (无结露)
保存温湿度范围	-20°C 至 60°C, 80% RH 以下 (无结露)
防尘和防水	IP40 (EN60529)
产品保证期	3 年 (不包括测量温度)
附件	<ul style="list-style-type: none">• L9206 测试线• 皮套 (安装在仪表上, 带有测试线支座)• 使用说明书• 5 号锰电池 (R6P) × 2 (仪表内未安装)
选件	参见: “选件 (另售)” (p. 2)

备件	用于电流端子 (μA , mA) 的 630 $\text{mA}/1000\text{ V}$ 熔断器 (分断能力 50 kA 快速熔断式: $\phi 6.3 \times 32\text{ mm}$, SIBA) 用于电流端子 (A) 的 10 $\text{A}/1000\text{ V}$ 熔断器 (分断能力 30 kA 快速熔断式: $\phi 10 \times 38\text{ mm}$, SIBA)
适用的标准	<ul style="list-style-type: none">• 安全: EN61010• EMC: EN61326

5.2 电气特性

噪声消除 NMRR	<ul style="list-style-type: none"> • DCV : -45 dB 或更高 (50 Hz/60 Hz)
噪声消除 CMRR	<ul style="list-style-type: none"> • DCV : -100 dB 或更高 (DC/50 Hz/60 Hz, 1kΩ 不平衡) • ACV : -60 dB 或更高 (DC/50 Hz/60 Hz, 1kΩ 不平衡) (而 1000 V 量程则为 -45 dB 或更高)
响应时间 (自动量程)	<ul style="list-style-type: none"> • DCV : 1.2 至 1.4 秒 (0 V \rightarrow 100 V 自动量程操作) • ACV : 0.7 至 0.9 秒 (0 V \rightarrow 100 V 自动量程操作) • Ω : 1.2 至 1.4 秒 (无穷大 \rightarrow 0Ω 自动量程操作)
显示更新率	测量值 : 3 次 /s (量程固定后, 不包括电阻、导通、静电容量、频率) 2 次 /s (电阻、导通) 0.5 至 2 次 /s (因静电容量而异) 5 次 /s (频率)
耐压	测量端子和外壳之间 AC 7.06 kV 正弦波 (50/60 Hz, 60 秒)
端子间的最大额定电压	V 端子 : DC 1000 V/AC 1000 V 或 10^6 V \cdot Hz
端子间的最大额定电流	电流端子 (A) : DC 10 A/AC 10 A 电流端子 (μ A, mA) DC 400 mA/AC 400 mA
输入端子对地最大额定电压	AC 1000 V (测量分类 II) AC 600 V (测量分类 III) 超前瞬态过电压 : 6000 V
额定电源电压	DC 1.5 V \times 2 5 号锰电池 (R6P) \times 2 5 号碱性电池 (LR6) \times 2
最大额定功率	100 mVA (最大值) 电源电压 3.0 V, 导通测量输入短路, 背光灯点亮

额定功率	<ul style="list-style-type: none">• 7.5 mVA +20% 或更低 电源电压 3.0 V, DCV 测量, 背光灯熄灭• 0.05 mVA +20% 或更低 电源电压 3.0 V, 自动节电功能激活
连续使用时间	5 号锰电池, DCV, 背光灯熄灭 DT4211 (平均值测量型): 大约 300 个小时 DT4212 (真有效值测量型): 大约 240 个小时 5 号碱性电池, DCV, 背光灯熄灭 DT4211 (平均值测量型): 大约 800 个小时 DT4212 (真有效值测量型): 大约 450 个小时

5.3 精度表

精度保证期	1 年
精度保证电源电压范围	2.4 V \pm 0.15 V 或更高 (直至 B 点亮)
精度保证温湿度范围	23°C \pm 5°C, 80%RH 以下 (无结露)
温度特性	加上“测量精度 \times 0.1/°C” (不包括 23°C \pm 5°C)。

- rdg. (读取或显示数值) : 当前测量的值并在测量仪表上显示。
- dgt. (分辨率) : 可显示的最小单位, 即最小数位的“1”。

1 交流电压

量程	精度 *1	输入阻抗
	40 至 500 Hz	
400.0 mV ²	$\pm 1.0\%$ rdg. ± 10 dgt.	11M Ω $\pm 2\%$ 100 pF 或更小
4.000 V	$\pm 1.0\%$ rdg. ± 5 dgt.	
40.00 V	$\pm 1.0\%$ rdg. ± 5 dgt.	10M Ω $\pm 2\%$ 100 pF 或更小
400.0 V		
1000 V		

- 过载保护 : DC 1100 V/AC 1100 V 或 10⁶ V \cdot Hz (通电 1 分钟)
瞬态过电压 : 6000 V
- 波峰因数 (仅限 DT4212 (真有效值测量型)) : 波峰因数在计数 2800 次为 2, 计数 4000 次时线性减少至 1.5。

*1: 精度指定为量程的 1% 或更高。

*2: 仅手动量程。

2 直流电压

量程	精度	输入阻抗
400.0 mV	±0.5% rdg. ±3 dgt.	100MΩ 以上
4.000 V		11MΩ ±2%
40.00 V	±0.5% rdg. ±3 dgt.	10MΩ +2%
400.0 V		
1000 V		

- 过载保护：DC 1100 V/AC 1100 V 或 10^6 V • Hz (通电 1 分钟)

3 电阻

量程	精度	测量电流	开路电压
400.0Ω	±0.5% rdg. ±3 dgt.	约 140 μA	0.5 V 直流以下
4kΩ	±0.5% rdg. ±2 dgt.		
40kΩ	±0.5% rdg. ±2 dgt.	约 40 μA	
400.0kΩ		约 4 μA	
4.000MΩ		约 400 nA	
40MΩ	±1.5% rdg. ±3 dgt.	约 40 nA	

- 过载保护：DC 1000 V/AC 1000 V 或 10^6 V • Hz (通电 1 分钟)
短路时的电流：300 μA 或更低
过载时的电流：稳态 15 mA 或更小，瞬态 0.8 A 或更小
- 最大容性负荷：10 mF
- 最大感性负荷：10 H

4 二极管

量程	精度	测量 电流	开路 电压
1.000 V	$\pm 10.0\%$ rdg.	0.5 mA	DC 3.0 V 或更低 电池电量消耗导致 电压下降

- 过载保护：DC 1000 V/AC 1000 V 或 10^6 V \cdot Hz (通电 1 分钟)
短路时的电流：0.7 mA 以下
过载时的电流：稳态 15 mA 或更小，瞬态 0.8 A 或更小

5 导通

量程	精度	测量 电流	开路 电压
400.0 Ω	$\pm 1.0\%$ rdg. ± 15 dgt.	约 140 μ A	0.5 V 直流以下

- 过载保护：DC 1000 V/AC 1000 V 或 10^6 V \cdot Hz (通电 1 分钟)
短路时的电流：300 μ A 或更低
过载时的电流：稳态 15 mA 或更小，瞬态 0.8 A 或更小
- 导通 ON 阈值：90 \pm 40 Ω 或更小 (蜂鸣器)
- 响应时间：0.5 ms 以上开路或短路检测。

6 静电容量

量程	精度	充电电流	开路电压
50.00 nF	$\pm 1.5\% \text{ rdg.} \pm 15 \text{ dgt.}$	约 30 μA	1.5 V 直流以下
500.0 nF	$\pm 2.0\% \text{ rdg.} \pm 5 \text{ dgt.}$		
5.000 μF	$\pm 5.0\% \text{ rdg.} \pm 5 \text{ dgt.}$		
50.00 μF			
100.0 μF			

- 过载保护：DC 1000 V/AC 1000 V 或 $10^6 \text{ V} \cdot \text{Hz}$ (通电 1 分钟)
短路时的电流：50 μA 或更低
过载时的电流：稳态 15 mA 或更小，瞬态 0.8 A 或更小
- 精度保证条件：执行调零后

7 频率

量程	精度	最小灵敏度电压
5.000 Hz	$\pm 0.1\% \text{ rdg.} \pm 3 \text{ dgt.}$	1.5 Vrms 或更高的方波
50.00 Hz		
500.0 Hz		
5.000 kHz		
50.00 kHz		
500.0 kHz	$\pm 0.1\% \text{ rdg.} \pm 3 \text{ dgt.}$	2.0 Vrms 或更高的方波
5.000 MHz		

- 测量范围：1 Hz 或更高

8 直流电流 (μA)

量程	精度	输入阻抗
400.0 μA	$\pm 1.2\% \text{ rdg.} \pm 3 \text{ dgt.}$	100 $\Omega \pm 5\%$
4000 μA		

- 过载保护：630 mA/1000 V 熔断器，分断能力 50 kA

9 交流电流 (μA)

量程	精度 ^{*1}	输入阻抗
400.0 μA	$\pm 1.2\% \text{ rdg.} \pm 5 \text{ dgt.}$	100 $\Omega \pm 5\%$
4000 μA		

- 过载保护：630 mA/1000 V 熔断器，分断能力 50 kA
- 波峰因数 (仅限 DT4212 (真有效值测量型))：波峰因数在计数 2800 次为 2，计数 4000 次时线性减少至 1.5。

*1: 精度指定为量程的 1% 或更高。

频率的精度保证范围：40 Hz 至 500 Hz (超出频率精度保证范围的测量值也会被显示。)

10 直流电流 (mA)

量程	精度	输入阻抗
40.00 mA	$\pm 1.2\% \text{ rdg.} \pm 3 \text{ dgt.}$	2 $\Omega \pm 40\%$
400.0 mA		

- 过载保护：630 mA/1000 V 熔断器，分断能力 50 kA

11 交流电流 (mA)

量程	精度 ^{*1}	输入阻抗
40.00 mA	±1.2% rdg. ±5 dgt.	2Ω ±40%
400.0 mA		

- 过载保护：630 mA/1000 V 熔断器，分断能力 50 kA
- 波峰因数 (仅限 DT4212 (真有效值测量型))：波峰因数在计数 2800 次为 2，计数 4000 次时线性减少至 1.5。

*1: 精度指定为量程的 1% 或更高。

频率的精度保证范围：40 Hz 至 500 Hz (超出频率精度保证范围的测量值也会被显示。)

12 直流电流 (A)

量程	精度	输入阻抗
4.000 A	±1.2% rdg. ±3 dgt.	0.05Ω ±40%
10.00 A		

- 过载保护：10 A/1000 V 熔断器，分断能力 30 kA

13 交流电流 (A)

量程	精度 ^{*1}	输入阻抗
4.000 A	±1.2% rdg. ±5 dgt.	0.05Ω ±40%
10.00 A		

- 过载保护：10 A/1000 V 熔断器，分断能力 30 kA
- 波峰因数 (仅限 DT4212 (真有效值测量型))：波峰因数在计数 2800 次为 2，计数 4000 次时线性减少至 1.5。

*1: 精度指定为量程的 1% 或更高。

频率的精度保证范围：40 Hz 至 500 Hz (超出频率精度保证范围的测量值也会被显示。)

14 温度

热电偶类型	量程	测量范围	精度 ^{*1}
K	400.0°C	-55.0°C 至 0.0°C	±2.0% rdg. ±2°C
		0.0°C 至 50.0°C	±2°C
		50.0°C 至 400.0°C	±2.0% rdg. ±1°C
	700°C	400°C 至 700°C	±2.0% rdg. ±1°C

- 过载保护：DC 1000 V/AC 1000 V 或 10^6 V·Hz (通电 1 分钟)
过载时的电流：稳态 15 mA 或更小，瞬态 0.8 A 或更小
 - 使用 DT4910 热电偶 (K)。
 - 精度不包括 DT4910 热电偶 (K) 的误差。
 - 显示更新率：3 次/s
- *1: 在本仪表温度稳定在 $\pm 1^\circ\text{C}$ 的环境中，精度指定。
主机标准接点温度补偿稳定时间：120 分钟 (当仪表环境温度从 50°C 快速变化至 23°C 时)

6

维护和检修

6.1 维修、检查和清洁

危险



不允许顾客改造、拆解或者维修本仪表。
这样做可能导致火灾、触电或者人身伤害。

校正

重要

为保证本仪表以规定的精度提供正确的测量结果，需要定期校正。

校正频率因本仪表的使用情况或者安装环境而异。建议客户根据本仪表的使用情况或者安装环境确定校正频率，向本公司提出校正委托。

清洁

- 清洁本仪表时，用沾上水或中性清洁剂的软布轻轻擦拭。
- 用柔软的干布轻轻擦拭显示器。

重要

绝不要使用苯、酒精、丙酮、醚、酮、稀释剂或者汽油等溶剂，因为这些东西会导致变形，并使外壳褪色。

报废

依据当地规定使用和处置本仪表。

6.2 故障诊断

- 当怀疑本仪表发生故障时，检查“送回本仪表维修前”记载的信息，然后联系代理店或距您最近的营业所。
- 当送回本仪表维修时，取出电池，并仔细包装，以防运输期间损坏。
包裹缓冲材料，这样本仪表就不能在包装中移动。务必附上详细的问题说明。
Hioki 不对运输期间发生的损坏负责。

送回本仪表维修前

症状	确认和处理方法
显示器上没有任何显示。 或者显示短时间后消失。	检查电池电量是否耗尽。 更换新电池。(p. 22)
	检查自动节电功能是否激活。 检查自动节电功能的设置。(p. 47)
测量值未显示。 即便测量后，仍然显示 0 (零)。 即使短接探头后，依然 不出现测量值。 不能调零。	如果测得的电流值不显示，检查熔断器是否烧断。 检查方法：“确认熔断器是否熔断。”(p. 30) 如果熔断器已烧断，更换指定的熔断器。(p. 64)
	如果测得的电流值不显示，检查熔断器是否变形。 取出熔断器时，如果用力过大，支座会变形。用针鼻钳夹持，并修复熔断器支座的形状。
	检查测试线是否破损。 执行导通检查，以确认测试线的导通。(p. 28) 如果测试线破损，更换测试线。
	<ul style="list-style-type: none"> 检查测试线是否插到底了。 检查测量方法是否是正确的。 如果没有发现问题，仪器可能发生了故障。将本仪表送回维修。
显示不稳定，并且数值波动，难以读取数值。	检查输入信号是否处于仪表的输入范围内。

其他咨询

问题	处理方法：
想执行调零。	使用相对值显示功能，可执行调零。(p. 46)
想更换熔断器。 想知道如何获得熔断器。	熔断器可通过 Hioki 授权经销商购买。
能使用充电电池吗？	充电电池可被使用。但是，因其放电特性与碱性电池不同，因此电池余量可能无法正常显示。请注意。

6.3 更换熔断器

如果熔断器烧坏，用下述新的熔断器更换。

如何检查熔断器是否烧坏的详细情况，参见“3 确认熔断器是否熔断。”(p. 30)。

警告



- 为避免触电，更换熔断器前，请先拆下测试线。
- 只使用指定型号、特性、额定电流、额定电压的熔断器进行更换。
不要使用指定以外的熔断器(尤其不要使用额定电流更大的熔断器)或者将其短接熔断器支座。这样做可能损坏本仪表，并导致人身伤害。

指定的熔断器

	额定参数	规格
用于 $\mu\text{A}/\text{mA}$ 端子	630 mA/1000 V	制造商：SIBA 熔断特性：快速熔断式 分断能力：50 kA 大小： $\phi 6.3 \text{ mm} \times 32 \text{ mm}$
用于 A 端子	10 A/1000 V	制造商：SIBA 熔断特性：快速熔断式 分断能力：30 kA 大小： $\phi 10 \text{ mm} \times 38 \text{ mm}$

熔断器可通过 Hioki 授权经销商购买。

取出熔断器时，不要向熔断器支座施加过大的力。如果熔断器支座变形造成接触不良，将会无法测量电流。

⚠ CAUTION



当更换熔断器时，不要让外部异物进入本仪表。此举可能导致故障。请勿使用仪表随附的测试线 L9206 的前端来拆下熔断器。否则测试线可能会弯曲变形。

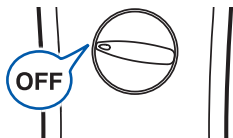

- 1 从本仪表上拆下测试线
- 2 将旋转开关切换到 OFF。

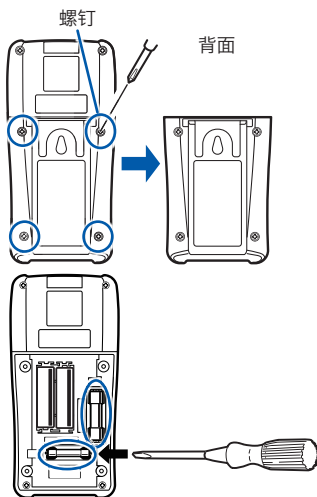

- 3 卸下皮套。
- 4 使用十字螺丝刀，从电池盖板上拆下螺钉(4处)。
- 5 拆下电池盖板。
- 6 更换熔断器。
- 7 重新装上电池盖板。
- 8 用螺钉紧固盖板。
- 9 装回皮套。

附录 1 有效值与平均值

有效值与平均值的区别

有两种方法可将交流值转换为有效值：“真有效值法（真有效值指示）”与“平均值法（平均值整流成有效值指示）”。

对于未失真的正弦波而言，两种方法指示相同的值。但是，如果波形失真，这两种方法将出现区别。

DT4211（平均值测量型）采用平均值法，而 DT4212（真有效值测量型）采用真有效值法。

在真有效值法中，高频成分也被包含和显示。

在平均值法中，输入波形被当做未失真的正弦波处理（只有单一频率成分）。求得交流信号的平均值后转换成有效值，然后显示。如果波形失真，会出现较为严重的测量误差。

测量例子	真有效值	平均整流
100 V 正弦波	100 V	100 V
100 V 矩形波	100 V	111 V

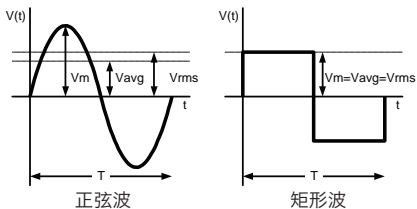

V_m : 最大值, V_{avg} : 平均值, V_{rms} : 有效值, T : 周期

保修证书

型号	序列号	保修期 自购买之日 (__ / __) 起三 (3) 年
<p>本产品为出厂前已在我司通过严格检验程序检查过的合格产品。</p> <p>如果在使用过程中发现问题，请与向您出售本产品的经销商联系，产品可根据本《保修证书》的相关规定获得免费维修。此保修自购买之日起三 (3) 年内有效。如果无法确定购买日期，则此保修将视为自产品生产日期起三 (3) 年有效。与经销商联系时请出示本《保修证书》。</p> <p>另外，精度以注明的精度保证期限为准。</p> <p>1. 如果保修期内产品符合《使用说明书》、本机注意标签（包括盖印标志）和其他警示信息的规定在正常使用情况下发生故障，可在原购买价格范围内获得免费维修。另外，因距产品生产日期的时间过长、零部件停产或不可预见情况发生等原因，我司可能会拒绝维修、校准等服务。</p> <p>2. 如果出现以下情况，即使在保修期内的产品由我司判定，也将被视为非保修对象：</p> <ul style="list-style-type: none">a. 使用本产品的测量结果，使被测物或由测量结果引起的二次或三次损坏b. 采用不符合《使用说明书》规定的方式对产品进行不当处理或使用而引起的故障c. 由未经 我司认可的公司、组织或个人对产品进行维修、调整或改装而引起的故障或损坏d. 产品零部件的损耗，包括《使用说明书》所述的损耗情况e. 由于产品购买后的运输、摔落或其他处理所导致的故障或损坏f. 产品外观发生变化（外壳划痕等）g. 由于火灾、风暴或洪水破坏、地震、雷击、电源异常（电压、频率等）、战争或暴动、辐射污染或其他不可抗力导致的故障或损坏h. 产品连接网络而造成的损坏i. 无法出示《保修证书》j. 用于特殊的嵌入式应用（航天设备、航空设备、核能设备、生命攸关的医疗设备或车辆控制设备等）但未能提前通知我司。k. 不属于我司责任范围的其他故障 <p>* 要求</p> <ul style="list-style-type: none">· 《保修证书》不补发，请注意妥善保管。· 请在表格中填写型号、序列号和购买日期。		
HIOKI E.E. CORPORATION 81 Koizumi, Ueda, Nagano 386-1192, Japan TEL: +81-268-28-0555 FAX: +81-268-28-0559		13-09

电子信息产品污染控制指示表

【DT4211, DT4212 数字万用表】

	有毒有害物质及元素					
	铅 (Pb)	汞 (Hg)	镉 (Cd)	六价铬 (Cr ⁶⁺)	多溴联苯 (PBB)	多溴联苯醚 (PBDE)
主机						
实装电路板	×	○	○	○	○	○
端子金属零件	×	○	○	○	○	○
其它						
测试线L9206	×	○	○	○	○	○
延长线L4931	×	○	○	○	○	○
测试针L4932	×	○	○	○	○	○
接触针L4933	×	○	○	○	○	○
测试夹L4936	×	○	○	○	○	○
磁铁接合器L4937	×	○	○	○	○	○
K型热电偶DT4910	×	○	○	○	○	○
○: 对应部件的所有均质材料中, 相对应的有毒有害物质的含量均低于SJ/T 11363-2006标准规定的限值。 ×: 至少此部件的均质材料中, 相对应的有毒有害物质的含量高于SJ/T 11363-2006标准规定的限值。						

环境保护使用期限



此标志中的年数, 列于 2006 年 2 月 28 日公布的【电子信息产品污染防治管理办法】, 是基于 SJ/T 11364-2006【电子信息产品污染控制标识要求】、在中华人民共和国制造进口的电子信息产品适用的环境保护使用期限。

只要遵守使用说明书上记载的、此产品安全与使用方面的注意事项, 从制造日算起的此年限内, 就不会发生由于使用产品引起有害物质外泄、突然变异, 而对使用者身体及财产造成严重影响的事件。

【环境保护使用期限】不是安全使用期限。

产品不适合继续使用, 需要废弃时, 请遵守电子信息产品回收·再利用相关的法律·规定, 感谢您的配合。

注: 此年数为【环境保护使用期限】, 并非产品的品质保证期限。与电池等附属品一同包装的情况下, 产品与附属品的环境保护使用期限可能会有所不同。

HIOKI

日置電機株式会社

总部

邮编: 386-1192 日本长野县上田市小泉81

电话: +81-268-28-0562 传真: +81-268-28-0568

电子邮件: os-com@hioki.co.jp

日置(上海)商贸有限公司

邮编: 200021 上海市淮海中路93号 大上海时代广场1608-1610室

电话: 021-63910090/63910092 传真: 021-63910360

电子邮件: info@hioki.com.cn

北京分公司(电子邮件: info-bj@hioki.com.cn)

广州分公司(电子邮件: info-gz@hioki.com.cn)

深圳分公司(电子邮件: info-sz@hioki.com.cn)

<http://www.hioki.cn/>

联系方式可能会有变动, 最新的联系方式请参考本公司网页。

1303

日置电机株式会社技术支持处编辑出版

- 在手册编写中所有合理的建议都会被采纳。

如果您发现哪里不清楚或有错误, 请联系您的供应商或日置(上海)商贸有限公司。

- 考虑到产品的发展, 此手册的内容会修改。
- 本手册内容涉及著作权保护, 禁止非法转载、复制及更改。

- For regional contact information, please go to our website at <http://www.hioki.com>.
- The Declaration of Conformity for instruments that comply to CE mark requirements may be downloaded from the Hioki website.
- All reasonable care has been taken in the production of this manual, but if you find any points which are unclear or in error, please contact your supplier or the International Sales and Marketing Department at Hioki headquarters.
- In the interests of product development, the contents of this manual are subject to revision without prior notice.
- The content of this manual is protected by copyright.
No reproduction, duplication or modification of the content is permitted without the authorization of Hioki E.E. Corporation.

HIOKI

HIOKI E. E. CORPORATION

Headquarters

81 Koizumi, Ueda, Nagano 386-1192, Japan
TEL +81-268-28-0562 FAX +81-268-28-0568
E-mail: os-com@hioki.co.jp

URL <http://www.hioki.com/>

(International Sales and Marketing Department)

HIOKI USA CORPORATION

E-mail: hioki@hiokiusa.com URL <http://www.hiokiusa.com>

HIOKI (Shanghai) Sales & Trading Co., Ltd.

E-mail: info@hioki.com.cn URL <http://www.hioki.cn>

HIOKI INDIA PRIVATE LIMITED

E-mail: hioki@hioki.in URL <http://www.hioki.in>

HIOKI SINGAPORE PTE. LTD.

E-mail: info@hioki.com.sg

1305